

Public

Common Criteria Information Technology Security Evaluation

**S3D384C/S3D352C/S3D300C/S3D264C/S3D2
32C/S3K384C**

Class: ASE

Version 3.0

14th April 2021

ST(Security Target) Lite

SAMSUNG ELECTRONICS RESERVES THE RIGHT TO CHANGE PRODUCTS, INFORMATION AND SPECIFICATIONS WITHOUT NOTICE.

Products and specifications discussed herein are for reference purposes only. All information discussed herein is provided on an "AS IS" basis, without warranties of any kind.

This document and all information discussed herein remain the sole and exclusive property of Samsung Electronics. No license of any patent, copyright, mask work, trademark or any other intellectual property right is granted by one party to the other party under this document, by implication, estoppel or otherwise.

Samsung products are not intended for use in life support, critical care, medical, safety equipment, or similar applications where product failure could result in loss of life or personal or physical harm, or any military or defense application, or any governmental procurement to which special terms or provisions may apply.

For updates or additional information about Samsung products, contact your nearest Samsung office.

All brand names, trademarks and registered trademarks belong to their respective owners.

© 2013 Samsung Electronics Co., Ltd. All rights reserved.

Important Notice

Samsung Electronics Co. Ltd. ("Samsung") reserves the right to make changes to the information in this publication at any time without prior notice. All information provided is for reference purpose only. Samsung assumes no responsibility for possible errors or omissions, or for any consequences resulting from the use of the information contained herein.

This publication on its own does not convey any license, either express or implied, relating to any Samsung and/or third-party products, under the intellectual property rights of Samsung and/or any third parties.

Samsung makes no warranty, representation, or guarantee regarding the suitability of its products for any particular purpose, nor does Samsung assume any liability arising out of the application or use of any product or circuit and specifically disclaims any and all liability, including without limitation any consequential or incidental damages.

Customers are responsible for their own products and applications. "Typical" parameters can and do vary in different applications. All operating parameters, including "Typicals" must be validated for each customer application by the customer's technical experts.

Samsung products are not designed, intended, or authorized for use in applications intended to support or sustain life, or for any other application in which the failure of the Samsung product could reasonably be expected to create a situation where personal injury or death may occur. Customers acknowledge and agree that they are solely responsible to meet all other legal and regulatory requirements regarding their applications using Samsung products notwithstanding any information provided in this

publication. Customer shall indemnify and hold Samsung and its officers, employees, subsidiaries, affiliates, and distributors harmless against all claims, costs, damages, expenses, and reasonable attorney fees arising out of, either directly or indirectly, any claim (including but not limited to personal injury or death) that may be associated with such unintended, unauthorized and/or illegal use.

WARNING No part of this publication may be reproduced, stored in a retrieval system, or transmitted in any form or by any means, electric or mechanical, by photocopying, recording, or otherwise, without the prior written consent of Samsung. This publication is intended for use by designated recipients only. This publication contains confidential information (including trade secrets) of Samsung protected by Competition Law, Trade Secrets Protection Act and other related laws, and therefore may not be, in part or in whole, directly or indirectly publicized, distributed, photocopied or used (including in a posting on the Internet where unspecified access is possible) by any unauthorized third party. Samsung reserves its right to take any and all measures both in equity and law available to it and claim full damages against any party that misappropriates Samsung's trade secrets and/or confidential information.

警告 本文件仅向经韩国三星电子株式会社授权的人员提供，其内容含有商业秘密保护相关法规规定并受其保护的三星电子株式会社商业秘密，任何直接或间接非法向第三人披露、传播、复制或允许第三人使用该文件全部或部分内容的行为（包括在互联网等公开媒介刊登该商业秘密而可能导致不特定第三人获取相关信息的行为）皆为法律严格禁止。此等违法行为一经发现，三星电子株式会社有权根据相关法规对其采取法律措施，包括但不限于提出损害赔偿请求。

Copyright © 2013 Samsung Electronics Co., Ltd.

Samsung Electronics Co., Ltd.
San #24 Nongseo-Dong, Giheung-Gu
Yongin-City, Gyeonggi-Do, Korea 446-711

Contact Us: junghyun.kim@samsung.com

Home Page: <http://www.samsungsemi.com>

Chip Handling Guide

Precaution against Electrostatic Discharge

When using semiconductor devices, ensure that the environment is protected against static electricity:

1. Wear antistatic clothes and use earth band.
2. All objects that are in direct contact with devices must be made up of materials that do not produce static electricity.
3. Ensure that the equipment and work table are earthed.
4. Use ionizer to remove electron charge.

Contamination

Do not use semiconductor products in an environment exposed to dust or dirt adhesion.

Temperature/Humidity

Semiconductor devices are sensitive to:

- Environment
- Temperature
- Humidity

High temperature or humidity deteriorates the characteristics of semiconductor devices. Therefore, do not store or use semiconductor devices in such conditions.

Mechanical Shock

Do not to apply excessive mechanical shock or force on semiconductor devices.

Chemical

Do not expose semiconductor devices to chemicals because exposure to chemicals leads to reactions that deteriorate the characteristics of the devices.

Light Protection

In non- Epoxy Molding Compound (EMC) package, do not expose semiconductor IC to bright light. Exposure to bright light causes malfunctioning of the devices. However, a few special products that utilize light or with security functions are exempted from this guide.

Radioactive, Cosmic and X-ray

Radioactive substances, cosmic ray, or X-ray may influence semiconductor devices. These substances or rays may cause a soft error during a device operation. Therefore, ensure to shield the semiconductor devices under environment that may be exposed to radioactive substances, cosmic ray, or X-ray.

EMS (Electromagnetic Susceptibility)

Strong electromagnetic wave or magnetic field may affect the characteristic of semiconductor devices during the operation under insufficient PCB circuit design for Electromagnetic Susceptibility (EMS).

Revision History

| Revision No. | Date | Description |
|--------------|---------------------------------|--|
| 0.0 | 10 th June 2020 | Creation |
| 1.0 | 15 th September 2020 | The table 1 is updated |
| 2.0 | 24 th November 2020 | The table 1 is updated, EHP is removed |
| 3.0 | 14 th April 2021 | The table 1 is updated |
| | | |
| | | |
| | | |
| | | |
| | | |
| | | |
| | | |
| | | |
| | | |
| | | |

TABLE OF CONTENTS

| | |
|--|-----------|
| 1 ST INTRODUCTION | 13 |
| 1.1 Security Target and TOE Reference | 14 |
| 1.2 TOE Overview and TOE Description | 15 |
| 1.2.1 Introduction..... | 15 |
| 1.2.2 TOE Definition..... | 15 |
| 1.2.3 TOE Features | 22 |
| 1.2.4 TOE Life cycle..... | 25 |
| 1.3 Interfaces of the TOE..... | 26 |
| 1.4 TOE Intended Usage..... | 27 |
| 2 CONFORMANCE CLAIMS | 28 |
| 2.1 CC Conformance Claim | 29 |
| 2.2 PP Claim | 29 |
| 2.3 Package Claim..... | 29 |
| 2.4 Conformance Claim Rationale | 29 |
| 3 SECURITY PROBLEM DEFINITION | 31 |
| 3.1 Description of Assets | 31 |
| 3.2 Threats | 34 |
| 3.2.1 Standard Threats | 36 |
| 3.2.2 Threats related to security services..... | 38 |
| 3.2.3 Threats related to additional TOE Specific Functionality | 39 |
| 3.2.4 Threats related to Authentication of the Security IC | 39 |
| 3.2.5 Threats related to Diffusion of open samples | 39 |
| 3.3 Organizational Security Policies | 40 |
| 3.4 Assumptions | 42 |
| 4 SECURITY OBJECTIVES | 44 |
| 4.1 Security Objectives for the TOE | 45 |
| 4.1.1 Standard Security Objectives..... | 46 |
| 4.1.2 Security Objectives related to Specific Functionality (referring to SG4) | 48 |
| 4.1.3 Security Objectives for Added Function..... | 49 |
| 4.2 Security Objectives for the Security IC Embedded Software | 51 |
| 4.2.1 Clarification of "Treatment of User Data of the Composite TOE(OE.Resp-Appl)" | 51 |
| 4.3 Security Objectives for the Operational Environment | 51 |
| 4.3.1 Clarification of "Protection during Composite Product Manufacturing (OE.Process-Sec-IC)" | 52 |
| 4.4 Security Objectives Rationale..... | 53 |
| 5 EXTENDED COMPONENTS DEFINITION..... | 57 |
| 5.1 Definition of the Family FCS_RNG..... | 58 |
| 5.2 Definition of the Family FMT_LIM..... | 58 |
| 5.3 Definition of the Family FAU_SAS | 61 |
| 5.4 Definition of the Family FDP_SDC | 62 |
| 5.5 Definition of the Family FIA_API..... | 63 |

| | |
|--|------------|
| 6 IT SECURITY REQUIREMENTS | 65 |
| 6.1 Security Functional Requirements for the TOE | 66 |
| 6.1.1 Malfunctions..... | 66 |
| 6.1.2 Abuse of Functionality | 66 |
| 6.1.3 Physical Manipulation and Probing | 67 |
| 6.1.4 Leakage..... | 69 |
| 6.1.5 Random Numbers (DTRNG FRO M) | 70 |
| 6.1.6 Memory Access Control | 71 |
| 6.1.7 Cryptographic Support..... | 73 |
| 6.1.8 Triple-DES Operation | 74 |
| 6.1.9 AES Operation..... | 74 |
| 6.1.10 Rivest-Shamir-Adleman (RSA) Operation (optional)..... | 74 |
| 6.1.11 Rivest-Shamir-Adleman (RSA) Key Generation (optional) | 75 |
| 6.1.12 Elliptic Curve DSA Operation (optional) | 75 |
| 6.1.13 Elliptic Curve DSA Key Generation (optional)..... | 76 |
| 6.1.14 Elliptic Curve Diffie-Hellman (ECDH) Key Agreement (optional) | 77 |
| 6.1.15 Secure Hash Algorithm (SHA) (optional)..... | 77 |
| 6.1.16 Bootloader | 78 |
| 6.1.17 Authentication Proof of Identity..... | 81 |
| 6.1.18 Summary of Security Functional Requirements | 82 |
| 6.2 TOE Assurance Requirements | 84 |
| 6.3 Security Requirements Rationale | 86 |
| 6.3.1 Rationale for the Security Functional Requirements | 86 |
| 6.3.2 Dependencies of Security Functional Requirements | 91 |
| 6.3.3 Rationale for the Assurance Requirements | 94 |
| 6.3.4 Security Requirements are Internally Consistent | 95 |
| 7 TOE SUMMARY SPECIFICATION | 98 |
| 7.1 List of Security Functional Requirements | 99 |
| 7.2 Architectural Design Summary | 107 |
| 8 ANNEX | 108 |
| 8.1 Glossary | 108 |
| 8.2 Abbreviations..... | 110 |
| 8.3 References | 111 |

List of Figures

| Figure Number | Title | Page Number |
|----------------------|---|--------------------|
| Figure 1 | S3D384C/S3D352C/S3D300C/S3D264C/S3D232C/S3K384C Block Diagram | 16 |
| Figure 1-2 | Privilege and User Modes | 22 |
| Figure 2 | Definition of “TOE Delivery” and responsible Parties | 26 |
| Figure 3 | Standard Threats..... | 35 |
| Figure 4 | Threats related to security service | 35 |
| Figure 5 | Interactions between the TOE and its outer world | 36 |
| Figure 6 | Policies | 40 |
| Figure 7 | Assumptions | 42 |
| Figure 8 | Standard Security Objectives | 45 |
| Figure 9 | Security Objectives related to Specific Functionality | 46 |

List of Tables

| Table Number | Title | Page Number |
|---------------------|--|--------------------|
| Table 1 | TOE Configuration | 21 |
| Table 4 | Security Objectives versus Assumptions, Threats or Policies..... | 54 |
| Table 5 | Security Functional Requirements defined in Smart Card IC Protection Profile | 82 |
| Table 6 | Augmented Security Functional Requirements | 83 |
| Table 8 | Dependencies of the Security Functional Requirements | 93 |

List of Conventions

Register RW Access Type Conventions

| Type | Definition | Description |
|------|--------------|---|
| R | Read Only | The application has permission to read the Register field. Writes to read-only fields have no effect. |
| W | Write Only | The application has permission to write in the Register field. |
| RW | Read & Write | The application has permission to read and writes in the Register field. The application sets this field by writing 1'b1 and clears it by writing 1'b0. |

Register Value Conventions

| Expression | Description |
|------------------|--|
| x | Undefined bit |
| X | Undefined multiple bits |
| ? | Undefined, but depends on the device or pin status |
| Device dependent | The value depends on the device |
| Pin value | The value depends on the pin status |

Reset Value Conventions

| Expression | Description |
|------------|---------------------------|
| 0 | Clears the register field |
| 1 | Sets the register field |
| x | Don't care condition |

Warning: Some bits of control registers are driven by hardware or write operation only. As a result the indicated reset value and the read value after reset might be different.

List of Terms

| Terms | Descriptions |
|--------------------------------|--|
| Application Data | All data managed by the Security IC Embedded Software in the application context. Application data comprise all data in the final Security IC. |
| Composite Product Integrator | Role installing or finalising the IC Embedded Software and the applications on platform transforming the TOE into the unpersonalised Composite Product after TOE delivery. The TOE Manufacturer may implement IC Embedded Software delivered by the Security IC Embedded Software Developer before TOE delivery (e.g. if the IC Embedded Software is implemented in ROM or is stored in the non-volatile memory as service provided by the IC Manufacturer or IC Packaging Manufacturer) |
| Composite Product Manufacturer | The Composite Product Manufacturer has the following roles (i) the Security IC Embedded Software Developer (Phase 1), (ii) the Composite Product Integrator (Phase 5) and (iii) the Personaliser (Phase 6). If the TOE is delivered after Phase 3 in form of wafers or sawn wafers (dice) he has the role of the IC Packaging Manufacturer (Phase 4) in addition. |
| End-consumer | User of the Composite Product in Phase 7. |
| IC Dedicated Software | IC proprietary software embedded in a Security IC (also known as IC firmware) and developed by the IC Developer. Such software is required for testing purpose (IC Dedicated Test Software) but may provide additional services to facilitate usage of the hardware and/or to provide additional services (IC Dedicated Support Software). |
| IC Dedicated Test Software | That part of the IC Dedicated Software (refer to above) which is used to test the TOE before TOE Delivery but which does not provide any functionality thereafter. |
| IC Dedicated Support Software | That part of the IC Dedicated Software (refer to above) which provides functions after TOE Delivery. The usage of parts of the IC Dedicated Software might be restricted to certain phases. |
| Initialisation Data | Initialisation Data defined by the TOE Manufacturer to identify the TOE and to keep track of the Security IC's production and further life-cycle phases are considered as belonging to the TSF data. These data are for instance used for traceability and for TOE identification (identification data). |
| Integrated Circuit (IC) | Electronic component(s) designed to perform processing and/or memory functions. |
| Pre-personalisation Data | Any data supplied by the Card Manufacturer that is injected into the non-volatile memory by the Integrated Circuits manufacturer (Phase 3). These data are for instance used for traceability and/or to secure shipment between phases. |
| Security IC | Composition of the TOE, the Security IC Embedded Software, User Data and the package (the Security IC carrier). |
| Security IC Embedded Software | Software embedded in a Security IC and normally not being developed by the IC Designer. The Security IC Embedded Software is designed in Phase 1 and embedded into the Security IC in Phase 3 or in later phases of the Security IC product life-cycle. Some part of that software may actually implement a Security IC application others may provide standard services. Nevertheless, this distinction doesn't matter here so that the Security IC Embedded Software can be considered as being application dependent whereas the IC Dedicated Software is definitely not. |

| | |
|---------------------|---|
| Security IC Product | Composite product which includes the Security Integrated Circuit (i.e. the TOE) and the Embedded Software and is evaluated as composite target of evaluation in the sense of the Supporting Document |
| TOE Delivery | The period when the TOE is delivered which is either (i) after Phase 3 (or before Phase 4) if the TOE is delivered in form of wafers or sawn wafers (dice) or (ii) after Phase 4 (or before Phase 5) if the TOE is delivered in form of packaged products. |
| TOE Manufacturer | The TOE Manufacturer must ensure that all requirements for the TOE and its development and production environment are fulfilled. The TOE Manufacturer has the following roles: (i) IC Developer (Phase 2) and (ii) IC Manufacturer (Phase 3). If the TOE is delivered after Phase 4 in form of packaged products, he has the role of the (iii) IC Packaging Manufacturer (Phase 4) in addition. |
| TSF data | Data created by and for the TOE, that might affect the operation of the TOE. This includes information about the TOE's configuration, if any is coded in non-volatile non-programmable memories (ROM), in specific circuitry, in non-volatile programmable memories (for instance E2PROM) or a combination thereof. |
| User data | All data managed by the Smartcard Embedded Software in the application context. User data comprise all data in the final Smartcard IC except the TSF data. |

List of Acronyms

| Acronyms | Descriptions |
|----------|----------------------------|
| CC | Common Criteria |
| EAL | Evaluation Assurance Level |
| IT | Information Technology |
| PP | Protection Profile |
| ST | Security Target |
| TOE | Target of Evaluation |
| TSC | TSF Scope of Control |
| TSF | TOE Security Feature |
| TSFI | TSF Interface |
| TSP | TOE Security Policy |
| | |

1 ST INTRODUCTION

- 1 This introductory chapter contains the following sections:
 - 1.1 Security Target and TOE Reference
 - 1.2 TOE Overview and TOE Description
 - 1.3 Interfaces of the TOE
 - 1.4 TOE Intended Usage

1.1 Security Target and TOE Reference

- 2 The Security Target Lite version is [3.0](#) and dated [14th April 2021](#).
The Security Target Lite is strictly compliant to
- 3 [5] Eurosmart Security IC Platform Protection Profile with Augmentation Packages, Version 1.0, BSI-CC-PP-0084-2014.
- 4 The Protection Profile and the Security Target are built on *Common Criteria version 3.1*.
- Title: [Security Target Lite of S3D384C/S3D352C/S3D300C/S3D264C/S3D232C/S3K384C](#)
- Target of Evaluation: S3D384C/S3D352C/S3D300C/S3D264C/S3D232C/S3K384C
 - TOE reference: [S3D384C_20210620](#)
 - Provided by: Samsung Electronics Co., Ltd.
 - Common Criteria version:
- 5 [1] Common Criteria, Part 1: Common Criteria for Information Technology Security Evaluation, Part 1: Introduction and General Model, Version 3.1, Revision 5, April 2017, CCMB-2017-04-001
- 6 [2] Common Criteria, Part 2: Common Criteria for Information Technology Security Evaluation, Part 2: Security Functional Components, Version 3.1, Revision 5, April 2017, CCMB-2017-04-002
- 7 [3] Common Criteria, Part 3: Common Criteria for Information Technology Security Evaluation, Part 3: Security Assurance Components, Version 3.1, Revision 5, April 2017, CCMB-2017-04-003
- 8 [4] Common Methodology for Information Technology Security Evaluation, Evaluation Methodology, Version 3.1, Revision 5, April 2017, CCMB-2017-04-004

1.2 TOE Overview and TOE Description

1.2.1 Introduction

- 9 The Target of Evaluation (TOE), the S3D384C/S3D352C/S3D300C/S3D264C/S3D232C/ S3K384C microcontroller featuring the TORNADO™-T cryptographic coprocessor, is a smartcard integrated circuit which is composed of a processing unit, security components, contactless and contact based I/O ports, hardware circuit for testing purpose during the manufacturing process and volatile and non-volatile memories (hardware). The TOE also includes any IC Designer/Manufacturer proprietary IC Dedicated Software as long as it physically exists in the smartcard integrated circuit after being delivered by the IC Manufacturer. Such software (also known as IC firmware) is used for testing purpose during the manufacturing process but also provides additional services to facilitate the usage of the hardware and/or to provide additional services, including optional public key cryptographic libraries, a random number generation library and a random number generator. The public key cryptographic libraries further include the functionality of hash computation. The use for keyed hash operations like HMAC or similar security critical operations involving keys and other secrets, is not subject of this TOE and requires specific security improvements and DPA analysis including the operating system, which is not part of this TOE. However, this functionality is intended to be used for signature generation and verification only. All other software is called Smartcard Embedded Software and is not part of the TOE.
- 10 Regarding the public key cryptographic libraries, the user has the possibility to tailor this IC Dedicated Software part of the TOE during the manufacturing process by deselecting the public key cryptographic libraries. Hence the TOE can be delivered with or without the functionality of the public key cryptographic libraries what's resulting in two TOE configurations. This is considered in this Security Target and corresponding notes (indicated by "optional") are added where required. If the user decides not to use the public key cryptographic libraries, the library is not delivered to the user and the accompanying Rivest-Shamir-Adleman (O.RSA) and Elliptic Curve Cryptography (O.ECC) is not provided by the TOE. Deselecting public key cryptographic libraries means excluding the code implementing functionality, which the user decided not to use. Excluding the code of the deselected functionality has no impact on any other security policy of the TOE, it is exactly equivalent to the situation where the user decides just not to use the functionality.
- 11 The difference between S3D384C/S3D352C/S3D300C/S3D264C/S3D232C and S3K384C is at the FLASH memory size & interfaces in a logical meaning, say, S3D384C(384KB), S3D352C(352KB), S3D300C(300KB), S3D264C(264KB), S3D232C(232KB), S3K384C(384KB) which means that all 6 microcontrollers have the same layout. The only contactless interface of S3K384C(384KB) is logically disconnected.

1.2.2 TOE Definition

- 12 The S3D384C/S3D352C/S3D300C/S3D264C/S3D232C/S3K384C single-chip CMOS micro-controller is designed and packaged specifically for "Smart Card" applications.
- 13 The SC000 CPU architecture of the S3D384C/S3D352C/S3D300C/S3D264C/S3D232C/S3K384C microcontroller follows the Harvard style, that is, it has separate program memory and data memory. Both instruction and data can be fetched simultaneously without causing a stall, using separate paths for memory access.
- 14 The main security features of the S3D384C/S3D352C/S3D300C/S3D264C/S3D232C/S3K384C integrated circuit are:
-

- Security sensors, detectors or filters
- Shields
- Life time detector
- Dedicated tamper-resistant design based on synthesizable glue logic and secure topology
- Dedicated hardware mechanisms against side-channel attacks
- Secure DES and AES Symmetric Cryptography support
- Secure TORNADO™-T coprocessor for the support of RSA and ECC cryptographic operations
- One Hardware Digital True Random Number Generator (DTRNG FRO M) that meets PTG.2 class of BSI-AIS31 (German scheme) and some of ANSSI RGS requirements (French Scheme).
- The IC Dedicated Software includes:
 - An optional modular arithmetic library for the support of RSA and ECC (with SHA) cryptographic operations
 - A DTRNG FRO M library built around Hardware DTRNG FRO M. This library meets some of ANSSI requirements (French scheme) as well as PTG.2 class of BSI-AIS31 (German scheme)

15 The main hardware blocks of the S3D384C/S3D352C/S3D300C/S3D264C/S3D232C/S3K384C Integrated Circuit are described in **Figure 1** below:

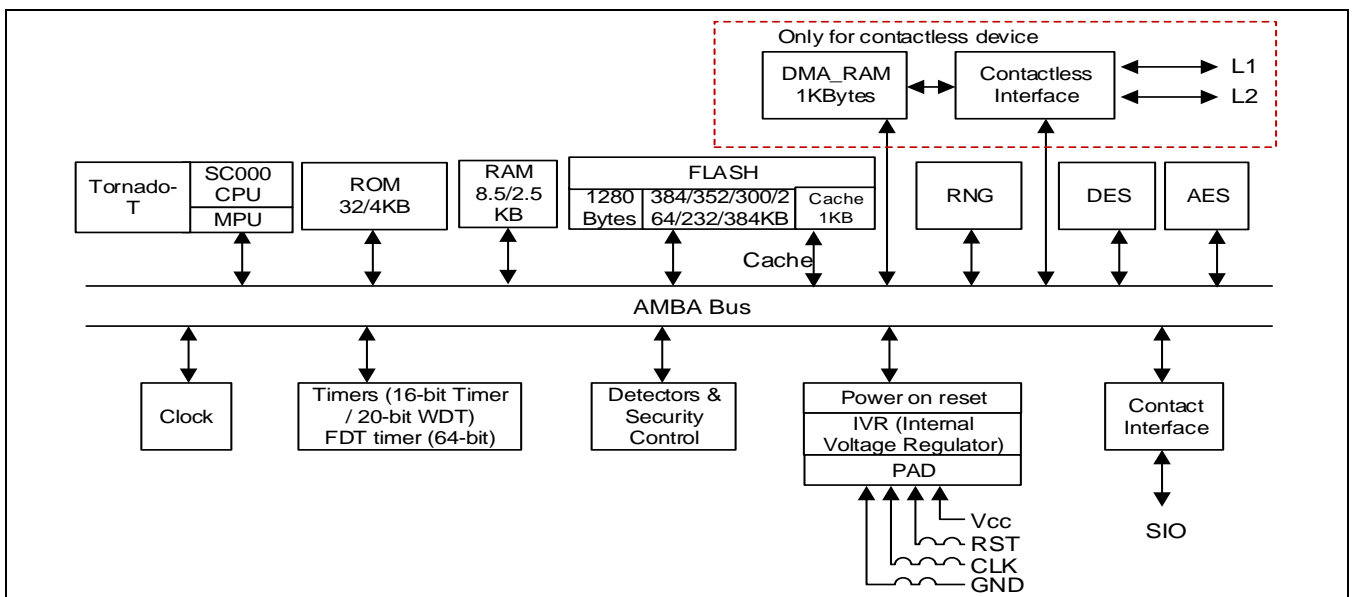

Figure 1 S3D384C/S3D352C/S3D300C/S3D264C/S3D232C/S3K384C Block Diagram

NOTE: That only the Triple DES algorithm belongs to the TOE, not the Single DES.

NOTE: CACHE is controlled by hardware of Flash. There is no address and then User software can't control CACHE.

The TOE consists of the following Hardware and Software:

TOE Hardware

- 384K/352K/300K/264K/232K/384Kbytes FLASH, 8.5Kbytes SRAM/ 2.5Kbytes Crypto RAM/ 1Kbytes Cache RAM/ 1Kbytes DMA_RAM, 32K/4K Bytes ROM, 1280 Bytes Flash special area
- 32-bit Central Processing Unit (CPU)
- Memory Protection Unit (MPU) up to 4 GB
- Internal Voltage Regulator (IVR)
- Power on Reset
- Internal Clock
- Detectors & Security Logic
- Digital True random number generator (DTRNG FROM)
- Triple DES cryptographic coprocessor with 112 or 168bits key size
- AES cryptographic coprocessor with 128 bits, 192bits and 256bits key size
- TORNADO™-T supporting modular multiplications for the operand size up to 4128-bit and modular additions/subtractions for the operand size up to 544-bit
- Hardware UART for contact and contactless I/O modes with 1KBytes DMA RAM
- Timers

TOE Software

16 The TOE software comprises the following components:

- The AT1 Secure RSA/ECC/SHA library (optional)
TORNADO™-T is a hardware coprocessor for high speed modular multiplications, modular additions and modular subtractions.
The AT1 Secure RSA/ECC/SHA library is a software library built on the TORNADO™-T coprocessor that provides high level interface for RSA and ECC cryptographic algorithms.
The RSA functions of the library included in the TOE are:

- RSA_KeyGen_Secure (RSA public/private key pair generation)
- TND_RSA_SigSTD_Secure (RSA signature generation with the standard method)
- TND_RSA_SigCRT_Secure (RSA signature generation with the CRT method)
- TND_RSA_Verify (RSA signature verification)
- RSA_R2modM_precompute_sec (R^2 value precomputation for the standard RSA)
- RSA_R2modPandQ_precompute_sec (R^2 value precomputation for the CRT RSA)

The library supports RSA operations of the key size from 32-bit to 2048-bit by step of 2-bit. However, only the key size from 1280-bit up to 2048-bit is within the scope of this evaluation.

The functions TND_RSA_SigSTD_Secure and TND_RSA_SigCRT_Secure implement some countermeasures against SPA, DPA and DFA attacks. The RSA_KeyGen_Secure function implements some countermeasures against SPA and DFA attacks. . Finally, the RSA_R2modM_precompute_sec and RSA_R2modPandQ_precompute_sec functions implement some countermeasures against the fault attack.

- The AT1 Secure RSA/ECC/SHA library provides a set of functions to implement ECC cryptographic algorithms. In particular, it provides some functions to implement the ECDSA signing/verifying and the ECDH key exchange protocol. The library implements ECC for general curves over prime fields of size from 192-bit to 512-bit and the only certain curves are in the scope of this evaluation. The ECC functions of the library included in the TOE are:
 - ECDSA_keygen (Ephemeral or static key pair generation for ECDSA signing/verifying)
 - ECDSA_sign_digest (ECDSA signature generation for a message digest)
 - ECDSA_verify_digest (ECDSA signature verification for a message digest)
 - ECDH_generate (ECDH secret key derivation)

The functions ECDSA_keygen, ECDSA_sign_digest and ECDH_generate implement some countermeasures against SPA, DPA and DFA for protecting the private key. The function ECDSA_verify_digest implements some countermeasures against DFA. The base point is assumed to be public.

Note1) The RSA/ECC/SHA library supports any valid elliptic curves over prime fields of size from 192-bit to 512-bit. However, the standard curves listed below whose security has been proven are in the scope of this evaluation.

1) [NIST curves]: Curves P-192, P-224, P-256, P-384

- 2) [*Brainpool curves*]: brainpoolP192r1, brainpoolP192t1, brainpoolP224r1, brainpoolP224t1, brainpoolP256r1, brainpoolP256t1, brainpoolP320r1, brainpoolP320t1, brainpoolP384r1, brainpoolP384t1, brainpoolP512r1, brainpoolP512t1
- 3) [*SEC-recommended curves*]: secp192k1, secp192r1, secp224k1, secp224r1, secp256k1, secp256r1, secp384r1

The AT1 Secure RSA/ECC/SHA library provides the functions for calculating hash (digest) values using the SHA1, SHA224, SHA256, SHA384 and SHA512 algorithms as specified in [FIPS PUB 180-3], but only those related to SHA224, SHA256, SHA384 and SHA512 listed below are within the scope of this evaluation:

- SHA224_init, SHA224_update, SHA224_final
- SHA256_init, SHA256_update, SHA256_final
- SHA384_init, SHA384_update, SHA384_final
- SHA512_init, SHA512_update, SHA512_final

These functions are not security relevant functions, i.e. they must not be used to hash security values like keys etc. There are implemented no countermeasures against side channel attacks. The TOE provides the functionality of hash computation if and only if the optional TORNADO™-T Secure RSA/ECC/SHA library is delivered.

- A Digital True Random Number Generator (DTRNG FROM) library that meets some of ANSSI requirements (French scheme) as well as PTG.2 class of BSI-AIS31(German scheme)
- Secure Boot Loader is a loader for downloading in Flash and can download the encrypted user code with AES

17 The TOE configuration is summarized in table 1 below:

| Item type | Item | Version | Date | Form of delivery |
|---------------------|--|---------|------------|---|
| Hardware | S3D384C/S3D352C/S3D300C/S3D264C/S3D232C/S3K384C 32-bit RISC Microcontroller for Smart Card | 1 | - | Wafer or Module |
| Software | Test ROM Code | 1.0 | - | - Included in S3D384C/S3D352C/S3D300C/S3D264C/S3D232C/S3K384C Test ROM - Test ROM code is not part of the TOE. |
| Software | Secure Boot loader (S3D384C_Bootloader_SystemAPI_Release_v0_3_20191120.zip) | 0.3 | 2019.11.20 | Included in S3D384C/S3D352C/S3D300C/S3D264C/S3D232C/S3K384C in ROM |
| Software | DTRNG FRO M library (S3D384C_DTRNG_FRO_M_Library_v2.2_20201019.zip) | 2.2 | 2020.10.19 | Software Library. This library is delivered as object file and is optionally integrated into user NVM code. |
| Software | DTRNG FRO M library (S3D384C_DTRNG_FRO_M_Library_v3.1_20210412.zip) | 3.1 | 2021.04.12 | Software Library. This library is delivered as object file and is optionally integrated into user NVM code. |
| Software (optional) | AT1 Secure RSA/ECC/SHA Library (20201103_PKA_lib_AT1_v4.02.zip) | 4.02 | 2020.11.03 | Software Library. This library is delivered as object file and is optionally integrated into user NVM code. |
| Document | DTRNG FRO M Application Note for DTRNG FRO M library v2.2 (S3D384C_DTRNG_FRO_M_AN_v1.3.pdf) | 1.3 | 2021.04.09 | Softcopy |
| Document | DTRNG FRO M Application Note for DTRNG FRO M library v3.1 (S3D384C_DTRNG_FRO_M_AN_v2.0.pdf) | 2.0 | 2021.04.09 | Softcopy |
| Document | AT1 RSA/ECC/SHA Library API Manual for AT1 Secure RSA/ECC/SHA Library v4.02 (AT1 RSA ECC Library API Manual v4.03.pdf) | 4.03 | 2020.11.04 | Softcopy |
| Document | Hardware User's manual (S3D384C Families_UM_REV0.05.pdf) | 0.05 | 2020. Oct | Softcopy |
| Document | Security Application Note for S3D384C family (SAN_S3D384C_v0.6.pdf) | 0.6 | 2021.02.05 | Softcopy |

| Item type | Item | Version | Date | Form of delivery |
|-----------|--|---------|------------|------------------|
| Document | Chip Delivery Specification (S3D384C Family_DV03.pdf) | 0.3 | May.2020 | Softcopy |
| Document | Boot Loader Specification (S3D384C Family_Bootloader_Specification_v0.3.pdf) | 0.3 | 2020.05.27 | Softcopy |
| Document | SC000 Reference Manual (SC000_Reference_Manual v0.0.pdf) | 0.0 | 2016.10.13 | Softcopy |

| Address | Items | The value |
|--|----------------------------|--|
| Refer to the chapter 7 in Delivery specification | Device type | Product: S3D384C → 0D0308040CH Product: S3D352C → 0D0305020CH Product: S3D300C → 0D0300000CH Product: S3D264C → 0D0206040CH Product: S3D232C → 0D0203020CH Product: S3K384C → 140308040CH |
| | IC Version | 01 |
| | Test ROM Code Version | 10 |
| | Boot loader code version | 03 |
| | Crypto. Library Version | 4.02 |
| | DTRNG FROM Library Version | 2.2, 3.1 |

Table 1 TOE Configuration

NOTE: The TOE can be delivered without the AT1 Secure Libraries. In this case the TOE does not provide the Additional Specific Security Functionality Rivest-Shamir-Adleman Cryptography and Elliptic Curve Cryptography (ECC) and Secure Hash Algorithm (SHA).

18 TEST mode, NORMAL mode and RESET mode

In NORMAL mode of the TOE, TOE can no longer go back to TEST mode domain again.

RESET mode of the TOE means that TOE doesn't operate before additional RESET signal.

19 PRIVILEGE mode and USER mode

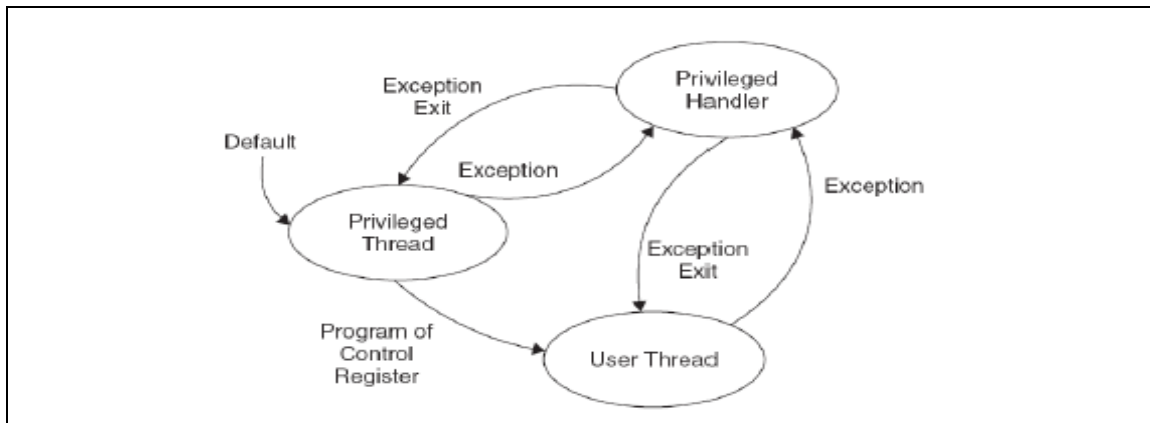

Figure 1-2 Privilege and User Modes

Code can execute as privileged or unprivileged.

Software in the privileged access level can switch the program into the user access level using the control register. A user program cannot change back to the privileged state by writing to the Control register. It has to go through an exception handler.

1.2.3 TOE Features

20 CPU

- SC000 32-bit core (MPU extension to 4GB)

21 Memory

- 36 KB MASK ROM (4 KB is only for Samsung test mode, 32 KB for bootloader)
- 384K/352K/300K/264K/232K/384Kbytes NOR flash memory (1 banks)
- 1280 bytes Data memory(Flash)
- 12 KB SRAM (8.5KBytes SRAM for general purpose / 2.5KBytes Crypto RAM /1KBytes Cache RAM)
- 1Kbyte DMA RAM for Contactless interface

22 FLASH Write Operations

23 Triple DES

- Built-in hardware Triple DES accelerator
- Circuit for resistance against SPA, DPA and safe error attacks

24 AES

- Built-in hardware AES accelerator

- Circuit for resistance against SPA, DPA and safe error attacks
- 25 TORNADO™-T
- Built-in hardware accelerator for big number calculation
- 26 Abnormal Condition Detectors
- Environmental & Life cycle detectors
- 27 Filters
- 28 Interrupts
- Nested Vector Interrupt Controller: 16ea
- 29 Serial I/O Interface
- T=0 and 1 (ISO 7816-3)
 - Hardware UART (ISO7816) supports T=0 and T=1 protocols
- 30 Contactless Interface
- Type A contactless interfaces compliant with the ISO 14443 standard
 - VHBR(Very High Bit Rate) TX compliant with the ISO 14443 amendment
- 31 Reset and Power Down Mode
- Power-on reset and external reset
- 32 Random Number Generator
- A Digital True random number generator (DTRNG FRO M): PTG.2 class compliant (German Scheme) and meeting some of ANSSI RGS requirements (French scheme)
- 33 Memory Protection Unit
- Memory Protection Unit(MPU) up to 4 GB
- 34 Memory Encryption and Bus Scrambling
-

35 Timers

- 16-Bit Timer programmable interval timer
- 20-bit Watchdog Timer
- FDT Timer for contactless

36 ECC

- ECC on Flash

37 CRC

- 16bit - CRC32 in ISO7816 interface

38 Clock Sources

- External clock: 1 MHz-10 MHz(Class A,B)
External clock: 1 MHz-7.5 MHz(Class C)
- Internal clock

39 Operating Voltage Range

- 1.62 V - 5.5 V

40 Operating Temperature

- - 25°C to 85°C

41 Package

- Wafer
- 8/6-pin COB (compliant with ISO 7816)

1.2.4 TOE Life cycle

- 42 The complex development and manufacturing processes of a Composite Product can be separated into seven distinct phases. The phases 2 and 3 of the Composite Product life cycle cover the IC development and production:

| Site / Building | phase |
|------------------|-----------|
| Hwasung Plant | Phase 2+3 |
| Giheung Plant | Phase 3 |
| Onyang Plant | Phase 3+4 |
| PKL Plant | Phase 3 |
| TOPPAN Plant | Phase 3 |
| HANAMICRON Plant | Phase 3+4 |
| Inesa Plant | Phase 3+4 |
| Eternal Plant | Phase 3+4 |
| TESNA Plant | Phase 3 |
| ASE Korea | Phase 3+4 |
| SFA Plant | Phase 4 |

- IC Development (Phase 2):
 - IC design,
 - IC Dedicated Software development,
 - the IC Manufacturing (Phase 3):
 - integration and photomask fabrication,
 - IC production,
 - IC testing,
 - preparation and
 - Pre-personalisation if necessary
- 43 The Composite Product life cycle phase 4 can be included in the evaluation of the IC as an option:
- the IC Packaging (Phase 4):
 - Security IC packaging (and testing),
 - Pre-personalization if necessary (if not done in phase 3)
- 44 In addition, three important stages have to be considered in the Composite Product life cycle:
- Security IC Embedded Software Development (Phase 1),
 - the Composite Product finishing process, preparation and shipping to the personalisation line for the Composite Product (Composite Product Integration Phase 5),

| Package in Phase 5 | Description |
|--|--|
| Package 1 (Static Mutual Authentication) | Loader dedicated for usage in Secured Environment only |
| Package 2 (Dynamic Mutual Authentication) | Loader dedicated for usage by authorized users only |

- the Composite Product personalisation and testing stage where the User Data is loaded into the Security IC's memory (Personalisation Phase 6),
- the Composite Product usage by its issuers and consumers (Operational Usage Phase 7) which may include loading and other management of applications in the field.

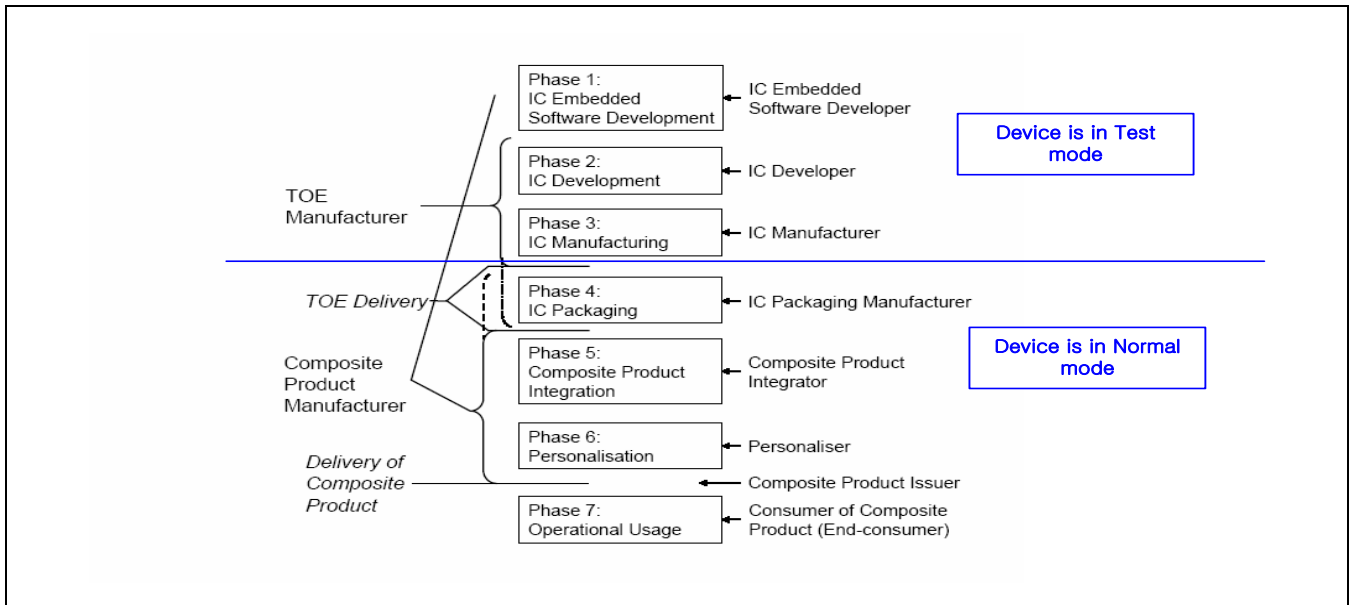

Figure 2 Definition of "TOE Delivery" and responsible Parties

- 45 The Security IC Embedded Software is developed outside the TOE development in Phase 1. The TOE is developed in Phase 2 and produced in Phase 3. Then the TOE is delivered in form of wafers. The TOE can also be delivered in form of packaged products. In this case, the development and production of the TOE not only pertain to Phase 2 and 3 but to Phase 4 in addition.

1.3 Interfaces of the TOE

- The physical interface of the TOE with the external environment is the entire surface of the IC
- The electrical interface of the TOE with the external environment is made of the chip's pads including the VDD, RESETB, XCLK, GND, SIO and L1 and L2 interface
- The data interface of the TOE is made of the Contact SIO and Contactless L1 and L2 pad.
- The software interface of the TOE with the hardware consists of Special Function Registers (SFR) and CPU instructions.
- The TRNG interface of the TOE is defined by DTRNG FRO M library interface.
- The Bootloader interface interface
- The RSA interface of the TOE is defined by the RSA/ECC/SHA library interface (optional).
- The interface to the ECC and SHA calculations is defined from the RSA/ECC/SHA library interface (optional)

1.4 TOE Intended Usage

46 The TOE is dedicated to applications such as:

- Banking and finance applications for credit or debit cards, electronic purse (stored value cards) and electronic commerce.
- Network based transaction processing such a mobile phones (GSM SIM cards), pay TV (subscriber and pay-per-view cards), communication highways (Internet access and transaction processing).
- Transport and ticketing applications (access control cards).
- Governmental cards (ID cards, health cards, driving licenses).
- Multimedia applications and Digital Right Management protection.

2 CONFORMANCE CLAIMS

47 This chapter 2 contains the following sections:

2.1 CC Conformance Claim

2.2 PP Claim

2.3 Package Claim

2.4 Conformance Claim Rationale

2.1 CC Conformance Claim

- 48 This Security target claims to be conformant to the Common Criteria version 3.1 R5.
- 49 Furthermore it claims to be CC Part 2 extended and CC Part 3 conformant. The extended Security Functional Requirements are defined in chapter 5.
- 50 This Security Target has been built with the Common Criteria for Information Technology Security Evaluation; Version 3.1 which comprises
- [1] Common Criteria, Part 1: Common Criteria for Information Technology Security Evaluation, Part 1: Introduction and General Model, Version 3.1, Revision 5, April 2017, CCMB-2017-04-001
 - [2] Common Criteria, Part 2: Common Criteria for Information Technology Security Evaluation, Part 2: Security Functional Components, Version 3.1, Revision 5, April 2017, CCMB-2017-04-002
 - [3] Common Criteria, Part 3: Common Criteria for Information Technology Security Evaluation, Part 3: Security Assurance Components, Version 3.1, Revision 5, April 2017, CCMB-2017-04-003
 - [4] Common Methodology for Information Technology Security Evaluation, Evaluation Methodology, Version 3.1, Revision 5, April 2017, CCMB-2017-04-004
- has been taken into account.

2.2 PP Claim

- 51 This Security Target is strictly compliant to the Security IC Platform Protection Profile [5]. The Security IC Platform Protection Profile is registered and certified by the Bundesamt für Sicherheit in der Informationstechnik (BSI) under the reference BSI-CC-PP-0084, Version 1.0, dated 01.2014.
- 52 This ST does not claim conformance to any other PP.

2.3 Package Claim

- 53 This Security Target is strictly compliant to the Security IC Platform Protection Profile [5] with additional packages:
- Package “ Authentication of the Security IC”
 - Package 1 (Static Mutual Authentication): Loader dedicated for usage in secured environment only
 - Package 2 (Dynamic Mutual Authentication): Loader dedicated for usage by authorized users only
- 54 The assurance level for this Security Target is EAL6 augmented with ASE_TSS.2.

2.4 Conformance Claim Rationale

- 55 This security target claims strict conformance only to one PP, the Security IC Platform Protection Profile [5].
- 56 The Evaluation Assurance Level (EAL) of the PP [5] is EAL 6 augmented with the assurance components ALC_DVS.2 and AVA_VAN.5. The Assurance Requirements of the TOE obtain the Evaluation Assurance Level 6 augmented with the assurance component ASE_TSS.2 for the TOE.

- 57 The Target of Evaluation (TOE) is a complete solution implementing a security integrated circuit (security IC) as defined in the PP [5] section 1.3.1, so the TOE is consistent with the TOE type in the PP [5].
- 58 The security problem definition of this security target is consistent with the statement of the security problem definition in the PP [5], as the security target claimed strict conformance to the PP [5]. Additional threats, organizational security policies and assumptions are introduced in chapter 3 of this ST, a rationale is given in chapter 4.4.
- 59 The security objectives of this security target are consistent with the statement of the security objectives in the PP [5], as the security target claimed strict conformance to the PP [5]. Additional security objectives are added in chapter 4.1 of this ST, a rationale is given in chapter 4.4.
- 60 The security requirements of this security target are consistent with the statement of the security requirements in the PP [5], as the security target claimed strict conformance to the PP [5]. Additional security requirements are added in chapter 6.1 of this ST, a rationale is given in chapter 6.3. All assignments and selections of the security functional requirements are done in the PP [5] and in this security target section 6.

3

SECURITY PROBLEM DEFINITION

61 This chapter 3 contains the following sections:

3.1 Description of Assets

3.2 Threats

3.3 Organizational Security Policies

3.4 Assumptions

3.1 Description of Assets

Assets regarding the Threats

62 The assets (related to standard functionality) to be protected are

- the User Data of the Composite TOE,
- the Security IC Embedded Software stored and in operation,
- the security services provided by the TOE for the Security IC Embedded Software.

63 The user (consumer) of the TOE places value upon the assets related to high-level security concerns:

SC1 integrity of user data of the Composite TOE,

SC2 confidentiality of user data of the Composite TOE being stored in the TOE's protected memory areas,

SC3 correct operation of the security services provided by the TOE for the Security IC Embedded Software.

Note the Security IC Embedded Software is user data and shall be protected while being executed/processed and while being stored in the TOE's protected memories.

64 The Security IC may not distinguish between user data which is public knowledge or kept confidential. Therefore the security IC shall protect the user data of the Composite TOE in integrity and in confidentiality if stored in protected memory areas, unless the Security IC Embedded Software chooses to disclose or modify it.

65 In particular integrity of the Security IC Embedded Software means that it is correctly being executed which includes the correct operation of the TOE's functionality. Parts of the Security IC Embedded Software which do not contain secret data or security critical source code, may not require protection from being disclosed. Other parts of the Security IC Embedded Software may need to be kept confidential since specific implementation details may assist an attacker.

- 66 The Protection Profile[5] requires the TOE to provide at least one security service: the generation of random numbers by means of a physical Random Number Generator. The Security Target may require additional security services as described in these packages or define TOE specific security services. It is essential that the TOE ensures the correct operation of all security services provided by the TOE for the Security IC Embedded Software.
- 67 According to the Protection Profile there is the following high-level security concern related to security service:
- SC4 deficiency of random numbers.
- 68 To be able to protect these assets (SC1 to SC4) the TOE shall self-protect its TSF. Critical information about the TSF shall be protected by the development environment and the operational environment. Critical information may include:
- logical design data, physical design data, IC Dedicated Software, and configuration data,
 - Initialisation Data and Pre-personalisation Data, specific development aids, test and characterisation related data, material for software development support, and photomasks.
- 69 Such information and the ability to perform manipulations assist in threatening the above assets.
- 70 Note that there are many ways to manipulate or disclose the user data of the Composite TOE: (i) An attacker may manipulate the Security IC Embedded Software or the TOE. (ii) An attacker may cause malfunctions of the TOE or abuse Test Features provided by the TOE. Such attacks usually require design information of the TOE to be obtained. They pertain to all information about (i) the circuitry of the IC (hardware including the physical memories), (ii) the IC Dedicated Software with the parts IC Dedicated Test Software (if any) and IC Dedicated Support Software (if any), and (iii) the configuration data for the TSF. The knowledge of this information may enable or support attacks on the assets. Therefore the TOE Manufacturer must ensure that the development and production of the TOE (refer to Section 1.2.3) is secure so that no restricted, sensitive, critical or very critical information is unintentionally made available for attacks in the operational phase of the TOE (cf. [8] for details on assessment of knowledge of the TOE in the vulnerability analysis).
- 71 The TOE Manufacturer must apply protection to support the security of the TOE. This not only pertains to the TOE but also to all information and material exchanged with the developer of the Security IC Embedded Software. This covers the Security IC Embedded Software itself if provided by the developer of the Security IC Embedded Software or any authentication data required to enable the download of software. This includes the delivery (exchange) procedures for Phase 1 and the Phases after TOE Delivery as far as they can be controlled by the TOE Manufacturer. These aspects enforce the usage of the supporting documents and the refinements of SAR defined in the protection profile.
- 72 The information and material produced and/or processed by the TOE Manufacturer in the TOE development and production environment (Phases 2 up to TOE Delivery) can be grouped as follows:
- logical design data,
 - physical design data,
 - IC Dedicated Software, Initialisation Data and Pre-personalisation Data,
 - Security IC Embedded Software, provided by the Security IC Embedded Software developer and implemented by the IC manufacturer,
 - specific development aids,
 - test and characterisation related data,
-

- material for software development support, and
 - photomasks and products in any form
- as long as they are generated, stored, or processed by the TOE Manufacturer.

3.2 Threats

- 73 The following explanations help to understand the focus of the threats and objectives defined below. For example, certain attacks are only one step towards a disclosure of assets, others may directly lead to a compromise of the application security.
- Manipulation of user data (which includes user data and code of the Composite TOE, stored in or processed by the Security IC) means that an attacker is able to alter a meaningful block of data. This should be considered for the threats T.Malfunction, T.Phys-Manipulation and T.Abuse-Func
 - Disclosure of user data (which may include user data and code of the Composite TOE, stored in protected memory areas or processed by the Security IC) or TSF data means that an attacker is realistically^{3F2} able to determine a meaningful block of data. This should be considered for the threats T.Leak-Inherent, T.Phys-Probing, T.Leak-Forced and T.Abuse-Func.
 - Manipulation of the TSF or TSF data means that an attacker is able to deliberately deactivate or otherwise change the behaviour of a specific security functionality in a manner which enables exploitation. This should be considered for the threat T.Malfunction, T.Phys-Manipulation and T.Abuse-Func.
- 74 The cloning of the functional behaviour of the Security IC on its physical and command interface is the highest level security concern in the application context. This should be considered for the threat T.Masquerade_TOE.
- 75 The cloning of that functional behaviour requires to (i) develop a functional equivalent of the Security IC Embedded Software, (ii) disclose, interpret and employ the user data of the Composite TOE stored in the TOE, and (iii) develop and build a functional equivalent of the Security IC using the input from the previous steps.
- 76 The Security IC is a platform for the Security IC Embedded Software which ensures that especially the critical user data of the Composite TOE are stored and processed in a secure way (refer to below). The Security IC Embedded Software must also ensure that critical user data of the Composite TOE are treated as required in the application context. In addition, the personalisation process supported by the Security IC Embedded Software (and perhaps by the Security IC in addition) must be secure. This last step is beyond the scope of this security target. As a result the threat "cloning of the functional behaviour of the Security IC on its physical and command interface" is averted by the combination of mechanisms which split into those being evaluated according to this security target (Security IC) and those being subject to the evaluation of the Security IC Embedded Software or Security IC and the corresponding personalisation process. Therefore, functional cloning is indirectly covered by the security concerns and threats described below.
- 77 The high-level security concerns are refined below by defining threats as required by the Common Criteria (refer to Figure 3). Note that manipulation of the TOE is only a means to threaten user data and is not a success for the attacker in itself.

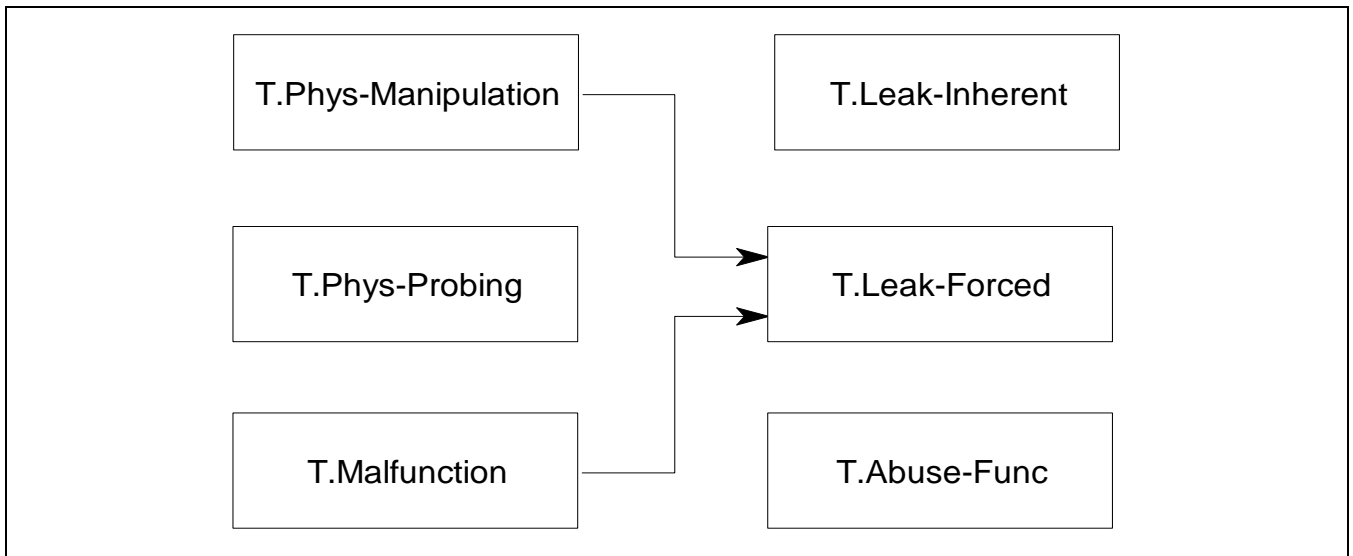

Figure 3 Standard Threats

78 The high-level security concern related to security service is refined below by defining threats as required by the Common Criteria (refer to Figure 4).

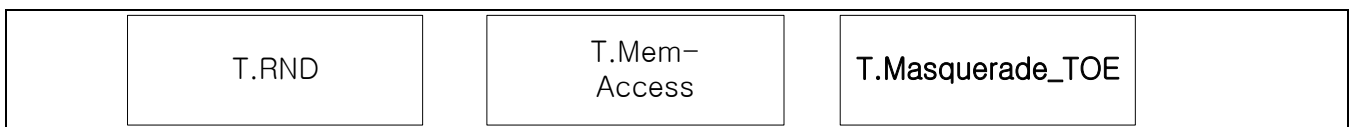

Figure 4 Threats related to security service

- 79 The Security IC Embedded Software must contribute to averting the threats: At least it must not undermine the security provided by the TOE.
- 80 The above security concerns are derived from considering the end-usage phase (Phase 7) since
- Phase 1 and the Phases from TOE Delivery up to the end of Phase 6 are covered by assumptions and
 - the development and production environment starting with Phase 2 up to TOE Delivery are covered by an organisational security policy.
- 81 The TOE's countermeasures are designed to avert the threats described below. Nevertheless, they may be effective in earlier phases (Phases 4 to 6).
- 82 The TOE is exposed to different types of influences or interactions with its outer world. Some of them may result from using the TOE only but others may also indicate an attack. The different types of influences or interactions are visualised in Figure 5. Due to the intended usage of the TOE all interactions are considered as possible.

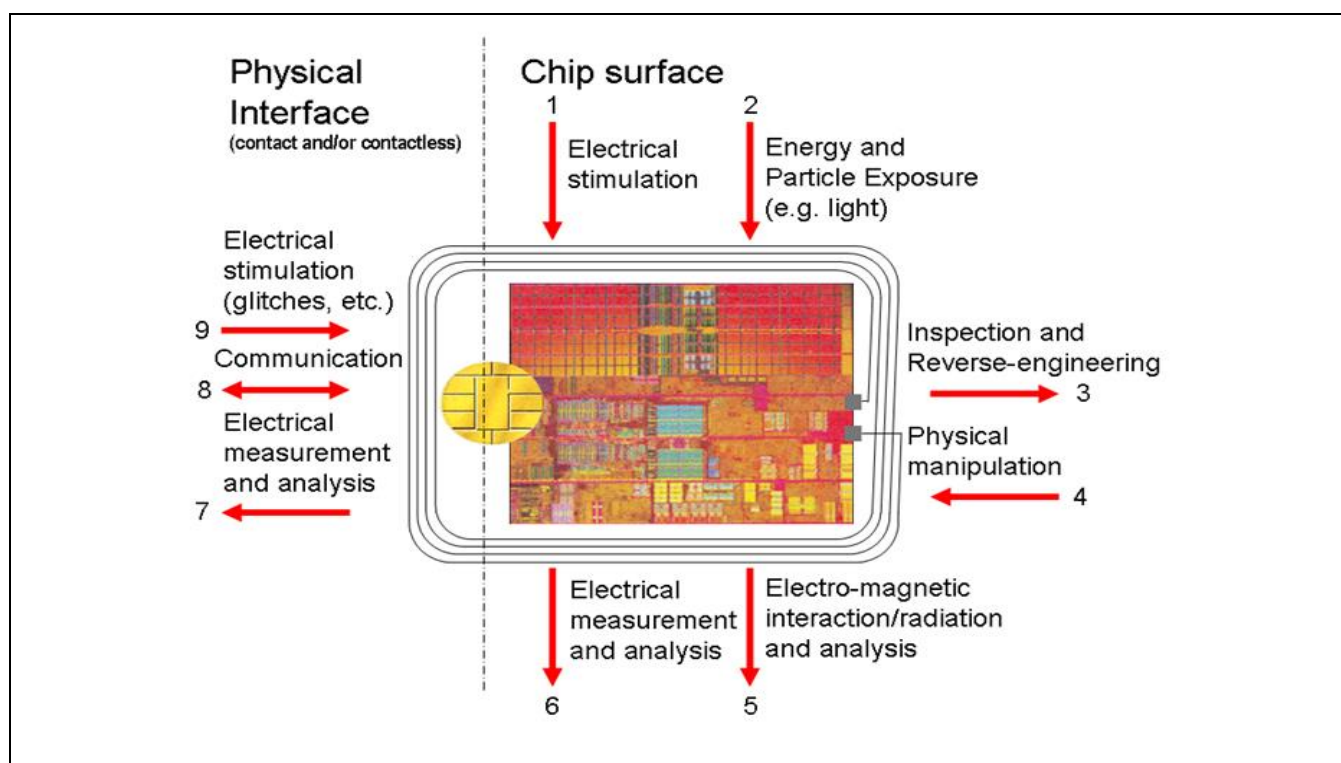

Figure 5 Interactions between the TOE and its outer world

83 An interaction with the TOE can be done through the physical interfaces (Number 7 – 9 in Figure 5) which are realised using contacts and/or a contactless interface. Influences or interactions with the TOE also occur through the chip surface (Number 1 – 6 in Figure 5). In Number 1 and 6 galvanic contacts are used. In Number 2 and 5 the influence (arrow directed to the chip) or the measurement (arrow starts from the chip) does not require a contact. Number 3 and 4 refer to specific situations where the TOE and its functional behaviour is not only influenced but definite changes are made by applying mechanical, chemical and other methods (such as 1, 2). Many attacks require a prior inspection and some reverse-engineering (Number 3). This demonstrates the basic building blocks of attacks. A practical attack will use a combination of these elements.

3.2.1 Standard Threats

84 The TOE shall avert the threat “Inherent Information Leakage (T.Leak-Inherent)” as specified below.

T.Leak-Inherent Inherent Information Leakage

An attacker may exploit information which is leaked from the TOE during usage of the Security IC in order to disclose confidential user data as part of the assets.

85 No direct contact with the Security IC internals is required here. Leakage may occur through emanations, variations in power consumption, I/O characteristics, clock frequency, or by changes in processing time requirements. One example is the Differential Power Analysis (DPA). This leakage may be interpreted as a covert channel transmission but is more closely related to measurement of operating parameters, which may be derived either from direct (contact) measurements (Numbers 6 and 7 in Figure 5) or measurement of emanations (Number 5 in Figure 5) and can then be related to the specific operation being performed.

86 The TOE shall avert the threat “Physical Probing (T.Phys-Probing)” as specified below.

T.Phys-Probing Physical Probing

An attacker may perform physical probing of the TOE in order (i) to disclose user data while stored in protected memory areas, (ii) to disclose/reconstruct the user data while processed or (iii) to disclose other critical information about the operation of the TOE to enable attacks disclosing or manipulating the user data of the Composite TOE or the Security IC Embedded Software.

- 87 Physical probing requires direct interaction with the Security IC internals (Numbers 5 and 6 in Figure 5). Techniques commonly employed in IC failure analysis and IC reverse engineering efforts may be used. Before that hardware security mechanisms and layout characteristics need to be identified (Number 3 in Figure 5). Determination of software design including treatment of user data of the Composite TOE may also be a pre-requisite.
- 88 This pertains to “measurements” using galvanic contacts or any type of charge interaction whereas manipulations are considered under the threat “Physical Manipulation (T.Phys-Manipulation)”. The threats “Inherent Information Leakage (T.Leak-Inherent)” and “Forced Information Leakage (T.Leak-Forced)” may use physical probing but require complex signal processing in addition.
- 89 The TOE shall avert the threat “Malfunction due to Environmental Stress (T.Malfunction)” as specified below.

T.Malfunction Malfunction due to Environmental Stress

An attacker may cause a malfunction of TSF or of the Security IC Embedded Software by applying environmental stress in order to (i) modify security services of the TOE or (ii) modify functions of the Security IC Embedded Software (iii) deactivate or affect security mechanisms of the TOE to enable attacks disclosing or manipulating the user data of the Composite TOE or the Security IC Embedded Software. This may be achieved by operating the Security IC outside the normal operating conditions (Numbers 1, 2 and 9 in Figure 5).

- 90 The modification of security services of the TOE may e.g. affect the quality of random numbers provided by the random number generator up to undetected deactivation when the random number generator does not produce random numbers and the Security IC Embedded Software gets constant values. In another case errors are introduced in executing the Security IC Embedded Software. To exploit this an attacker needs information about the functional operation, e.g. to introduce a temporary failure within a register used by the Security IC Embedded Software with light or a power glitch.
- 91 The TOE shall avert the threat “Physical Manipulation (T.Phys-Manipulation)” as specified below.

T.Phys-Manipulation Physical Manipulation

An attacker may physically modify the Security IC in order to (i) modify user data of the Composite TOE, (ii) modify the Security IC Embedded Software, (iii) modify or deactivate security services of the TOE, or (iv) modify security mechanisms of the TOE to enable attacks disclosing or manipulating the user data of the Composite TOE or the Security IC Embedded Software.

- 92 The modification may be achieved through techniques commonly employed in IC failure analysis (Numbers 1, 2 and 4 in Figure 5) and IC reverse engineering efforts (Number 3 in Figure 5). The modification may result in the deactivation of a security feature. Before that hardware security mechanisms and layout characteristics need to be identified. Determination of software design including treatment of

user data of the Composite TOE may also be a pre-requisite. Changes of circuitry or data can be permanent or temporary.

93 In contrast to malfunctions (refer to T.Malfunction) the attacker requires gathering significant knowledge about the TOE's internal construction here (Number 3 in Figure 5).

94 The TOE shall avert the threat "Forced Information Leakage (T.Leak-Forced)" as specified below:

T.Leak-Forced Forced Information Leakage

An attacker may exploit information which is leaked from the TOE during usage of the Security IC in order to disclose confidential user data of the Composite TOE as part of the assets even if the information leakage is not inherent but caused by the attacker.

95 This threat pertains to attacks where methods described in "Malfunction due to Environmental Stress" (refer to T.Malfunction) and/or "Physical Manipulation" (refer to T.Phys-Manipulation) are used to cause leakage from signals (Numbers 5, 6, 7 and 8 in Figure 5) which normally do not contain significant information about secrets.

96 The TOE shall avert the threat "Abuse of Functionality (T.Abuse-Func)" as specified below.

T.Abuse-Func Abuse of Functionality

An attacker may use functions of the TOE which may not be used after TOE Delivery in order to (i) disclose or manipulate user data of the Composite TOE, (ii) manipulate (explore, bypass, deactivate or change) security services of the TOE or (iii) manipulate (explore, bypass, deactivate or change) functions of the Security IC Embedded Software or (iv) enable an attack disclosing or manipulating the the user data of the Composite TOE or the Security IC Embedded Software.

3.2.2 Threats related to security services

97 The TOE shall avert the threat "Deficiency of Random Numbers (T.RND)" as specified below.

T.RND Deficiency of Random Numbers

An attacker may predict or obtain information about random numbers generated by the TOE security service for instance because of a lack of entropy of the random numbers provided.

An attacker may gather information about the random numbers produced by the TOE security service. Because unpredictability is the main property of random numbers this may be a problem in case they are used to generate cryptographic keys. The entropy provided by the random numbers must be appropriate for the strength of the cryptographic algorithm, the key or the cryptographic variable is used for. Here the attacker is expected to take advantage of statistical properties of the random numbers generated by the TOE. Malfunctions or premature ageing are also considered which may assist in getting information about random numbers.

3.2.3 Threats related to additional TOE Specific Functionality

98 The TOE shall avert the additional threat “Memory Access Violation (T.Mem-Access)” as specified below.

T.Mem-Access Memory Access Violation

Parts of the IC Smartcard Embedded Software may cause security violations by accidentally or deliberately accessing restricted data (which may include code). Any restrictions are defined by the security policy of the specific application context and must be implemented by the Smartcard IC Embedded Software.

Clarification: This threat does not address the proper definition and management of the security rules implemented by the Security IC Embedded Software, this being software design and correctness issue. This threat addresses the reliability of the abstract machine targeted by the software implementation. To avert the threat, the set of access rules provided by this TOE should be undefeated if operated according to the provided guidance. The threat is not realized if the Security IC Embedded Software is designed or implemented to grant access to restricted information. It is realized if an implemented access denial is granted under unexpected conditions or if the execution machinery does not effectively control a controlled access.

Here the attacker is expected to (i) take advantage of flaws in the design and/or the implementation of the TOE memory access rules (refer to T.Abuse-Func but for functions available after TOE delivery), (ii) introduce flaws by forcing operational conditions (refer to T.Malfunction) and/or by physical manipulation (refer to T.Phys-Manipulation). This attacker is expected to have a high level potential of attack.

3.2.4 Threats related to Authentication of the Security IC

The TOE shall avert the threat “Masquerade the TOE (T. Masquerade_TOE)” as specified below.

T.Masquerade_TOE Masquerade the TOE

An attacker may threaten the property being a genuine TOE by producing a chip which is not a genuine TOE but wrongly identifying itself as genuine TOE sample.

The threat T.Masquerade_TOE may threaten the unique identity of the TOE as described in the P.Process-TOE or the property as being a genuine TOE without unique identity. Mitigation of masquerade requires tightening up the identification by authentication.

3.2.5 Threats related to Diffusion of open samples

The TOE shall avert the threat “Diffusion of open samples(T.Open_Samples_Diffusion)” as specified below.

T.Open_Samples_Diffusion Diffusion of open samples

An attacker may get access to open samples of the TOE and use them to gain information about the TSF (loader, memory management unit, ROM code, ...). He may also use the open samples to characterize the behavior of the IC and its security functionalities (for example: characterization of side channel profiles, perturbation cartography, ...). The execution of a dedicated security features (for example: execution of a DES computation without countermeasures or by de-

activating countermeasures) through the loading of an adequate code would allow this kind of characterization and the execution of enhanced attacks on the IC.

3.3 Organizational Security Policies

99 The following Figure 6 shows the policies applied in this Security Target.

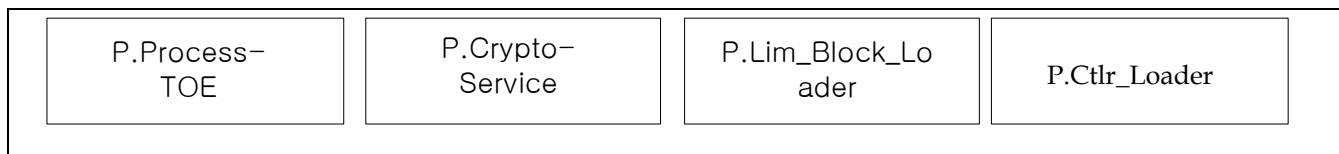

Figure 6 Policies

100 The IC Developer / Manufacturer must apply the policy “Identification during TOE Development and Production (P.Process-TOE)” as specified below.

P.Process-TOE Identification during TOE Development and Production

An accurate identification must be established for the TOE. This requires that each instantiation of the TOE carries this unique identification.

101 The accurate identification is introduced at the end of the production test in phase 3. Therefore the production environment must support this unique identification.

102 The information and material produced and/or processed by the TOE Manufacturer in the TOE development and production environment (Phases 2 up to TOE Delivery) can be grouped as follows:

- logical design data,
- physical design data,
- IC Dedicated Software, Security IC Embedded Software, Initialisation Data and Pre-personalisation Data,
- specific development aids,
- test and characterisation related data,
- material for software development support, and
- photomasks and products in any form

as long as they are generated, stored, or processed by the TOE Manufacturer.

103 The TOE provides specific cryptographic services which can be used by the Smartcard Embedded Software. In the following specific cryptographic services are listed which is not derived from threats identified for the TOE’s environment because it can only be decided in the context of the smartcard applications, against which threats the Smartcard Embedded Software will use the specific cryptographic service.

The IC Developer / Manufacturer must apply the policy “Cryptographic Service (P.Crypto-Service)” as specified below.

P.Crypto-Service Cryptographic Services provided by the TOE

The TOE shall provide the following cryptographic services to the IC Embedded Software:

- Triple Data Encryption Standard (TDES)
- Advanced Encryption Standard (AES)
- Rivest-Shamir-Adleman (RSA) public key asymmetric cryptography (optional)
- Elliptic Curve Cryptography (ECC) (optional)
- Secure Hash Algorithm (SHA) (optional)

Note: The TOE can be delivered without the RSA/ECC/SHA crypto library. In this case the TOE does not provide the Additional Specific Security Functionality Rivest-Shamir-Adleman Cryptography and Elliptic Curve Cryptography (ECC) and Secure Hash Algorithm (SHA).

The IC Developer / Manufacturer must apply the organisational security policy “Limiting and Blocking the Loader Functionality (P.Lim_Block_Loader)” applies to Loader dedicated for usage in secured environment specified below.

P.Lim_Block_Loader Limiting and Blocking the Loader Functionality

The composite manufacturer uses the Loader for loading of Security IC Embedded Software, user data of the Composite Product or IC Dedicated Support Software in charge of the IC Manufacturer. He limits the capability and blocks the availability of the Loader in order to protect stored data from disclosure and manipulation.

The organizational security policy “Controlled usage to Loader Functionality (P.Ctrl_Loader)” applies to Loader dedicated for usage by authorized users only.

P.Ctrl_Loader Controlled usage to Loader Functionality

Authorized user controls the usage of the Loader functionality in order to protect stored and loaded user data from disclosure and manipulation.

3.4 Assumptions

104 The following Figure 7 shows the assumptions applied in this Security Target.



Figure 7 Assumptions

105 The intended usage of the TOE is twofold, depending on the Life Cycle Phase: (i) The Security IC Embedded Software developer use it as a platform for the Security IC software being developed. The Composite Product Manufacturer (and the consumer) uses it as a part of the Security IC. The Composite Product is used in a terminal which supplies the Security IC (with power and clock) and (at least) mediates the communication with the Security IC Embedded Software.

106 Before being delivered to the consumer the TOE is packaged. Many attacks require the TOE to be removed from the carrier. Though this extra step adds difficulties for the attacker no specific assumptions are made here regarding the package.

107 Appropriate “Protection during Packaging, Finishing and Personalisation (A.Process-Sec-IC)” must be ensured after TOE Delivery up to the end of Phase 6, as well as during the delivery to Phase 7 as specified below.

A.Process-Sec-IC Protection during Packaging, Finishing and Personalisation

It is assumed that security procedures are used after delivery of the TOE by the TOE Manufacturer up to delivery to the end-consumer to maintain confidentiality and integrity of the TOE and of its manufacturing and test data (to prevent any possible copy, modification, retention, theft or unauthorised use).

This means that the Phases after TOE Delivery are assumed to be protected appropriately.

108 The information and material produced and/or processed by the Security IC Embedded Software Developer in Phase 1 and by the Composite Product Manufacturer can be grouped as follows:

- the Security IC Embedded Software including specifications, implementation and related documentation,
- Pre-personalisation Data and Personalisation Data including specifications of formats and memory areas, test related data,
- the user data of the Composite TOE and related documentation, and
- material for software development support

109 as long as they are not under the control of the TOE Manufacturer. Details must be defined in the Protection Profile or Security Target for the evaluation of the Security IC Embedded Software and/or Security IC.

110 The developer of the Security IC Embedded Software must ensure the appropriate usage of Security IC while developing this software in Phase 1 as described in the (i) TOE guidance documents (refer to the

Common Criteria assurance class AGD) such as the hardware data sheet, and the hardware application notes, and (ii) findings of the TOE evaluation reports relevant for the Security IC Embedded Software as documented in the certification report.

- 111 The Security IC Embedded Software must ensure the appropriate “Treatment of user data of the Composite TOE (A.Resp-Appl)” as specified below.

A.Resp-Appl Treatment of user data of the Composite TOE

All user data of the Composite TOE are owned by Security IC Embedded Software. Therefore, it must be assumed that security relevant user data of the Composite TOE (especially cryptographic keys) are treated by the Security IC Embedded Software as defined for its specific application context.

- 112 The application context specifies how the user data of the Composite TOE shall be handled and protected. The evaluation of the Security IC according to this Security Target is conducted on generalized application context. The concrete requirements for the Security IC Embedded Software shall be defined in the Protection Profile respective Security Target for the Security IC Embedded Software. The Security IC cannot prevent any compromise or modification of user data of the Composite TOE by malicious Security IC Embedded Software.

- 113 The developer of the Smartcard Embedded Software must ensure the appropriate “Usage of Key-dependent Functions (A.Key-Function)” while developing this software in Phase 1 as specified below.

A.Key-Function Usage of Key-dependent Functions

Key-dependent functions (if any) shall be implemented in the Smartcard Embedded Software in a way that they are not susceptible to leakage attacks (as described under T.Leak-Inherent and T.Leak-Forced).

- 114 Note that here the routines which may compromise keys when being executed are part of the Smartcard Embedded Software. In contrast to this the threats T.Leak-Inherent and T.Leak-Forced address (i) the cryptographic routines which are part of the TOE and (ii) the processing of User Data including cryptographic keys.

4 SECURITY OBJECTIVES

115 This chapter Security Objectives contains the following sections:

4.1 *Security Objectives for the TOE*

4.2 *Security Objectives for the Security IC Embedded Software*

4.3 *Security Objectives for the operational Environment*

4.4 *Security Objectives Rationale*

4.1 Security Objectives for the TOE

116 The user have the following standard high-level security goals related to the assets:

SG1 maintain the integrity user data (when being executed/processed and when being stored in the TOE's memories) as well as

SG2 maintain the confidentiality of user data (when being processed and when being stored in the TOE's protected memories).

SG3 maintain the correct operation of the security services provided by the TOE for the Security IC Embedded Software.

117 Note, the Security IC may not distinguish between user data which are public known or kept confidential. Therefore the security IC shall protect the user data in integrity and in confidentiality if stored in protected memory areas, unless the Security IC Embedded Software chooses to disclose or modify it. Parts of the Security IC Embedded Software which do not contain secret data or security critical source code, may not require protection from being disclosed. Other parts of the Security IC Embedded Software may need kept confidential since specific implementation details may assist an attacker.

118 These standard high-level security goals in the context of the security problem definition build the starting point for the definition of security objectives as required by the Common Criteria (refer to Figure 8). Note that the integrity of the TOE is a means to reach these objectives.

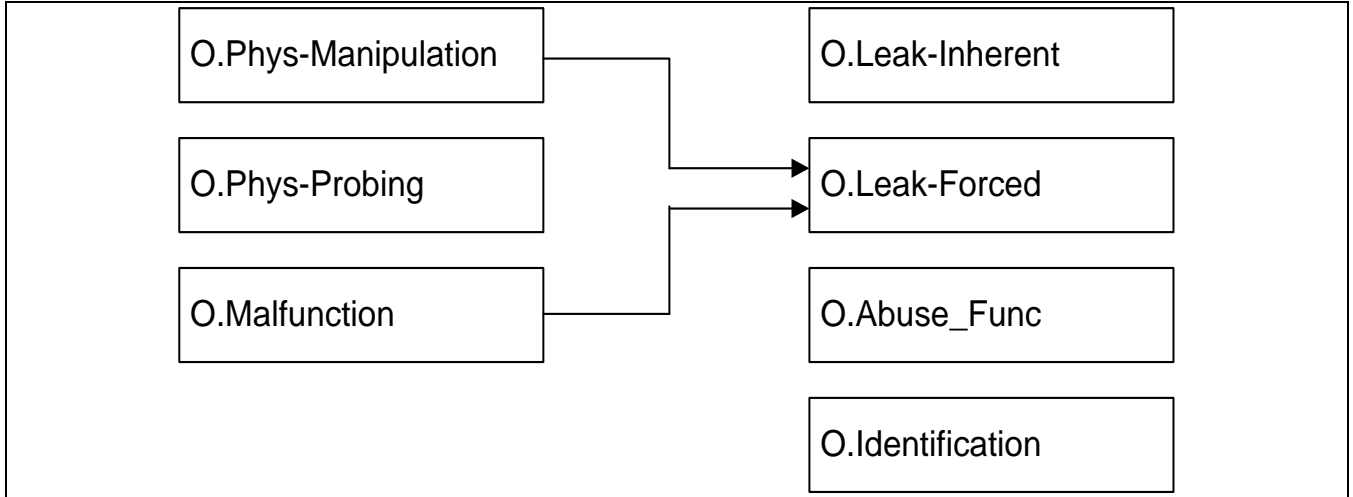

Figure 8 Standard Security Objectives

119 According to this Protection Profile there is the following high-level security goal related to specific functionality:

120 SG4 provide random numbers.

121 The additional high-level security considerations are refined below by defining security objectives as

required by the Common Criteria (refer to Figure 9).

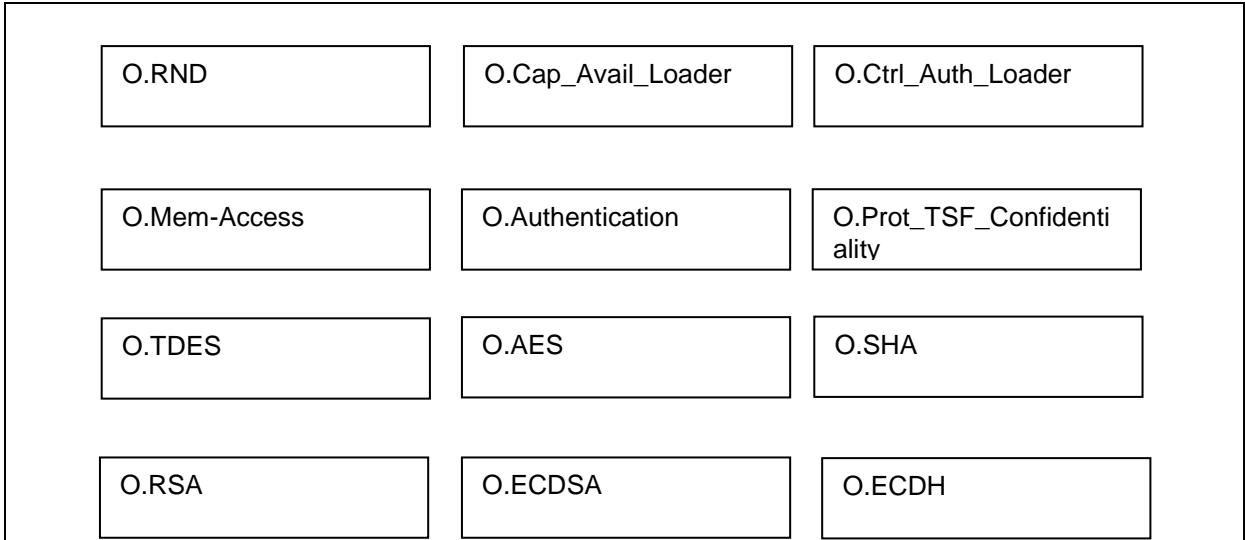

Figure 9 Security Objectives related to Specific Functionality

4.1.1 Standard Security Objectives

122 The TOE shall provide "Protection against Inherent Information Leakage (O.Leak-Inherent)" as specified below.

O.Leak-Inherent

Protection against Inherent Information Leakage

The TOE must provide protection against disclosure of confidential data (User Data or TSF data) stored and/or processed in the Smartcard IC

- by measurement and analysis of the shape and amplitude of signals (for example on the power, clock, or I/O lines) and
- by measurement and analysis of the time between events found by measuring signals (for instance on the power, clock, or I/O lines).

This objective pertains to measurements with subsequent complex signal processing whereas O.Phys-Probing is about direct measurements on elements on the chip surface. Details correspond to an analysis of attack scenarios which is not given here.

123 The TOE shall provide "Protection against Physical Probing (O.Phys-Probing)" as specified below.

O.Phys-Probing

Protection against Physical Probing

The TOE must provide protection against disclosure/reconstruction of user data while stored in protected memory areas and processed or against the disclosure of other critical information about the operation of the TOE.

This includes protection against

- measuring through galvanic contacts which is direct physical probing on the chips surface except on pads being bonded (using standard tools for measuring voltage and current) or
- measuring not using galvanic contacts but other types of physical interaction between charges (using tools used in solid-state physics research and IC failure analysis)

with a prior reverse-engineering to understand the design and its properties and functions.

The TOE must be designed and fabricated so that it requires a high combination of complex equipment, knowledge, skill, and time to be able to derive detailed design information or other information which could be used to compromise security through such a physical attack.

124 The TOE shall provide “Protection against Malfunctions (O.Malfunction)” as specified below.

O.Malfunction

Protection against Malfunctions

The TOE must ensure its correct operation.

The TOE must indicate or prevent its operation outside the normal operating conditions where reliability and secure operation has not been proven or tested. This is to prevent malfunctions. Examples of environmental conditions are voltage, clock frequency, temperature, or external energy fields.

Remark: A malfunction of the TOE may also be caused using a direct interaction with elements on the chip surface. This is considered as being a manipulation (refer to the objective O.Phys-Manipulation) provided that detailed knowledge about the TOE’s internal construction is required and the attack is performed in a controlled manner.

125 The TOE shall provide “Protection against Physical Manipulation (O.Phys-Manipulation)” as specified below.

O.Phys-Manipulation

Protection against Physical Manipulation

The TOE must provide protection against manipulation of the TOE (including its software and TSF data), the Smartcard Embedded Software and the user data of the Composite TOE. This includes protection against

- reverse-engineering (understanding the design and its properties and functions),
- manipulation of the hardware and any data, as well as
- undetected manipulation of memory contents.

The TOE must be designed and fabricated so that it requires a high combination of complex equipment, knowledge, skill, and time to be able to derive detailed design information or other information which could be used to compromise security through such a physical attack.

126 The TOE shall provide “Protection against Forced Information Leakage (O.Leak-Forced)” as specified below:

O.Leak-Forced

Protection against Forced Information Leakage

The Security IC must be protected against disclosure of confidential data processed in the Security IC (using methods as described under O.Leak-Inherent) even if the information leakage is not inherent but caused by the attacker

- by forcing a malfunction (refer to “Protection against Malfunction due to Environmental Stress (O.Malfunction)” and/or
- by a physical manipulation (refer to “Protection against Physical Manipulation (O.Phys-Manipulation)”).

If this is not the case, signals which normally do not contain significant information about secrets could become an information channel for a leakage attack.

127 The TOE shall provide “Protection against Abuse of Functionality (O.Abuse-Func)” as specified below.

O.Abuse-Func

Protection against Abuse of Functionality

The TOE must prevent that functions of the TOE which may not be used after TOE Delivery can be abused in order to (i) disclose critical user data of the Composite TOE, (ii) manipulate critical user data of the Composite TOE, (iii) manipulate Security IC Embedded Software or (iv) bypass, deactivate, change or explore security features or security services of the TOE. Details depend, for instance, on the capabilities of the Test Features provided by the IC Dedicated Test Software which are not specified here.

128 The TOE shall provide “TOE Identification (O.Identification)” as specified below:

O.Identification

TOE Identification

The TOE must provide means to store Initialisation Data and Pre-personalisation Data in its non-volatile memory. The Initialisation Data (or parts of them) are used for TOE identification.

4.1.2 Security Objectives related to Specific Functionality (referring to SG4)

129 The TOE shall provide “Random Numbers (O.RND)” as specified below.

O.RND

Random Numbers

The TOE will ensure the cryptographic quality of random number generation. For instance random numbers shall not be predictable and shall have sufficient entropy.

The TOE will ensure that no information about the produced random numbers is available to an attacker since they might be used for instance to generate cryptographic keys.

4.1.3 Security Objectives for Added Function

- 130 The TOE shall provide “Area based Memory Access Control (O.Mem-Access)” as specified below.

O.Mem-Access Area based Memory Access Control

The TOE must provide the Smartcard Embedded Software with the capability to define restricted access memory areas. The TOE must then enforce the partitioning of such memory areas so that access of software to memory areas is controlled as required, for example, in a multi-application environment.

- 131 The TOE shall provide “Capability and availability of the Loader (O.Cap_Avail_Loader)” as specified below.

O.Cap_Avail_Loader

Capability and availability of the Loader

The TSF provides limited capability of the Loader functionality and irreversible termination of the Loader in order to protect stored user data from disclosure and manipulation.

- 132 The TOE shall provide “Access control and authenticity for the Loader (O.Ctrl_Auth_Loader)” as specified below.

O.Ctrl_Auth_Loader

Access control and authenticity for the Loader

The TSF provides trusted communication channel with authorized user, supports confidentiality protection and authentication of the user data to be loaded and access control for usage of the Loader functionality.

- 133 The TOE shall provide “Cryptographic service Triple-DES (O.TDES)” as specified below.

O.TDES

Cryptographic service Triple-DES

The TOE provides secure hardware based cryptographic services implementing the Triple-DES for encryption and decryption.

- 134 The TOE shall provide “Cryptographic service AES (O.AES)” as specified below.

O.AES

Cryptographic service AES

The TOE provides secure hardware based cryptographic services for the AES for encryption and decryption.

135 The TOE shall provide “Cryptographic service Hash function (O.SHA)” as specified below.

O.SHA Cryptographic service Hash function

The TOE provides secure software based cryptographic services for secure hash calculation.

136 The TOE shall provide “Cryptographic service Rivest-Shamir-Adleman (O.RSA)” as specified below.

O.RSA Cryptographic service Rivest-Shamir-Adleman

The TOE provides secure software based cryptographic services for Cryptographic operation and Cryptographic key generation.

137 The TOE shall provide “Cryptographic service Elliptic Curve DSA (O.ECDSA)” as specified below.

O.ECDSA Cryptographic service Elliptic Curve DSA

The TOE provides secure software based cryptographic services for Cryptographic operation and Cryptographic key generation.

138 The TOE shall provide “Cryptographic service Elliptic Curve Diffie-Hellman (O.ECDH)” as specified below.

O.ECDH Cryptographic service Elliptic Curve Diffie-Hellman

The TOE provides secure software based cryptographic services for Cryptographic operation.

139 The Security IC Embedded Software shall provide “Authentication to external entities (O.Authentication)” as specified below.

O. Authentication Authentication to external entities

The TOE shall be able to authenticate itself to external entities. The Initialisation Data (or parts of them) are used for TOE authentication verification data.

140 The TOE shall provide “Protection of the confidentiality of the TSF (O.Prot_TSF_Confidentiality)” as specified below.

O.Prot_TSF_Confidentiality Protection of the confidentiality of the TSF

The TOE must provide protection against disclosure of confidential operations of the Security IC (loader, memory management unit, ...) through the use of a dedicated code loaded on open samples.

4.2 Security Objectives for the Security IC Embedded Software

- 141 The development of the Security IC Embedded Software is outside the development and manufacturing of the TOE. The Security IC Embedded Software defines the operational use of the TOE. This section describes the security objective for the Security IC Embedded Software.

Note, in order to ensure that the TOE is used in a secure manner the Security IC Embedded Software shall be designed so that the requirements from the following documents are met: (i) hardware data sheet for the TOE, (ii) data sheet of the IC Dedicated Software of the TOE, (iii) TOE application notes, other guidance documents, and (iv) findings of the TOE evaluation reports relevant for the Security IC Embedded Software as referenced in the certification report.

- 142 The Security IC Embedded Software shall provide “Treatment of user data of the Composite TOE (OE.Resp-Appl)” as specified below.

OE.Resp-Appl Treatment of user data of the Composite TOE

Security relevant user data of the Composite TOE (especially cryptographic keys) are treated by the Security IC Embedded Software as required by the security needs of the specific application context.

For example the Security IC Embedded Software will not disclose security relevant user data of the Composite TOE to unauthorised users or processes when communicating with a terminal.

4.2.1 Clarification of “Treatment of User Data of the Composite TOE(OE.Resp-Appl)”

- 143 Regarding the cryptographic services this objective of the environment has to be clarified. By definition cipher or plain text data and cryptographic keys are User Data. The Smartcard Embedded Software shall treat these data appropriately, use only proper secret keys (chosen from a large key space) as input for the cryptographic function of the TOE and use keys and functions appropriately in order to ensure the strength of cryptographic operation.
- 144 This means that keys are treated as confidential as soon as they are generated. The keys must be unique with a very high probability, as well as cryptographically strong. If keys are imported into the TOE and/or derived from other keys, quality and confidentiality must be maintained. This implies that appropriate key management has to be realised in the environment.
- 145 Regarding the area based access control this objective of the environment has to be clarified. The treatment of User Data of the Composite TOE is also required when a multi-application operating system is implemented as part of the Smartcard Embedded Software on the TOE. In this case the multi-application operating system should not disclose security relevant user data of one application to another application when it is processed or stored on the TOE.

4.3 Security Objectives for the Operational Environment

TOE Delivery up to the End of Phase 6

- 146 Appropriate “Protection during Packaging, Finishing and Personalisation (OE.Process-Sec-IC)” must be ensured after TOE Delivery up to the end of Phases 6, as well as during the delivery to Phase 7 as specified below.

OE.Process-Sec-IC Protection during composite product manufacturing

Security procedures shall be used after TOE Delivery up to delivery to the "end-consumer" to maintain confidentiality and integrity of the TOE and of its manufacturing and test data (to prevent any possible copy, modification, retention, theft or unauthorised use).

This means that Phases after TOE Delivery up to the end of Phase 6 must be protected appropriately.

The operational environment of the TOE shall provide "Limitation of capability and blocking the Loader (OE.Lim_Block_Loader)" as specified below.

OE.Lim_Block_Loader Limitation of capability and blocking the Loader

The Composite Product Manufacturer will protect the Loader functionality against misuse, limit the capability of the Loader and terminate irreversibly the Loader after intended usage of the Loader and before the end of phase 5.

Note: To maintain the confidentiality of the data of the composite TOE, the intended usage of the Loader is limited to the phase 5 of the life cycle.

The operational environment of the TOE shall provide "Secure communication and usage of the Loader (OE.Loader_Usage)" as specified below.

OE.Loader_Usage Secure communication and usage of the Loader

The authorized user must support the trusted communication channel with the TOE by confidentiality protection and authenticity proof of the data to be loaded and fulfilling the access conditions required by the Loader

The operational environment shall provide "External entities authenticating of the TOE (OE.TOE_Auth)".

OE.TOE_Auth External entities authenticating of the TOE

The operational environment shall support the authentication verification mechanism and know authentication reference data of the TOE.

4.3.1 Clarification of "Protection during Composite Product Manufacturing (OE.Process-Sec-IC)"

- 147 The protection during packaging, finishing and personalization includes also the personalization process and the personalization data during Phase 4, Phase 5 and Phase 6.
- 148 Since OE.Process-Sec-IC requires the Composite Product Manufacturer to implement those measures assumed in A.Process-Sec-IC, the assumption is covered by this objective.

4.4 Security Objectives Rationale

149 Table 4 below gives an overview, how the assumptions, threats, and organisational security policies are addressed by the objectives. The text following after the table justifies this in detail.

| Assumption, Threat or Organisational Security Policy | Security Objective | Notes |
|--|--|------------------------------------|
| A.Resp-Appl | OE.Resp-Appl | Phase 1 |
| P.Process-TOE | O.Identification | Phase 2 – 3 optional Phase 4 |
| A.Process-Sec-IC | OE.Process-Sec-IC | Phase 5 – 6 optional Phase 4 |
| T.Leak-Inherent | O.Leak-Inherent | |
| T.Phys-Probing | O.Phys-Probing | |
| T.Malfunction | O.Malfunction | |
| T.Phys-Manipulation | O.Phys-Manipulation | |
| T.Leak-Forced | O.Leak-Forced | |
| T.Abuse-Func | O.Abuse-Func | |
| T.RND | O.RND | |
| T.Mem-Access | O.Mem-Access | |
| P.Crypto-Service | O.TDES O.AES O.RSA O.ECDSA O.ECDH O.SHA | |
| A.Key-Function | OE.Resp-Appl | |
| P.Lim_Block_Loader | O.Cap_Avail_Loader OE.Lim_Block_Loader | Phase 5 |
| P.Ctrl_Loader | O.Ctrl_Auth_Loader OE.Loader_Usage | Phase 5 |
| T.Masquerade_TOE | O.Authentication OE.TOE_Auth | |
| T.Open_Samples_Diffusion | O.Prot_TSF_Confidentiality O.Leak-Inherent O.Leak-Forced | Phase 4, 5 |

Table 4 Security Objectives versus Assumptions, Threats or Policies

150 The justification related to the assumption “Treatment of user data of the Composite TOE (A.Resp-Appl)” is as follows:

151 Since OE.Resp-Appl requires the Security IC Embedded Software to implement measures as assumed in

A.Resp-AppI, the assumption is covered by the objective.

- 152 The justification related to the organisational security policy “Protection during TOE Development and Production (P.Process-TOE)” is as follows:
- 153 O.Identification requires that the TOE has to support the possibility of a unique identification. The unique identification can be stored on the TOE. Since the unique identification is generated by the production environment the production environment must support the integrity of the generated unique identification. The technical and organisational security measures that ensure the security of the development environment and production environment are evaluated based on the assurance measures that are part of the evaluation. For a list of material produced and processed by the TOE Manufacturer refer to paragraph 44. All listed items and the associated development and production environments are subject of the evaluation. Therefore, the organisational security policy P.Process-TOE is covered by this objective, as far as organisational measures are concerned.
- 154 The justification related to the assumption “Protection during Packaging, Finishing and Personalisation (A.Process-Sec-IC)” is as follows:
- 155 Since OE.Process-Sec-IC requires the Composite Product Manufacturer to implement those measures assumed in A.Process-Sec-IC, the assumption is covered by this objective.
- 156 The justification related to the threats “Inherent Information Leakage (T.Leak-Inherent)”, “Physical Probing (T.Phys-Probing)”, “Malfunction due to Environmental Stress (T.Malfunction)”, “Physical Manipulation (T.Phys-Manipulation)”, “Forced Information Leakage (T.Leak-Forced)”, “Abuse of Functionality (T.Abuse-Func)” and “Deficiency of Random Numbers (T.RND)” is as follows:
- 157 For all threats the corresponding objectives are stated in a way, which directly corresponds to the description of the threat. It is clear from the description of each objective, that the corresponding threat is removed if the objective is valid. More specifically, in every case the ability to use the attack method successfully is countered, if the objective holds.
- 158 The justification related to the threat “Memory Access Violation (T.Mem-Access)” is as follows:
- 159 According to O.Mem-Access the TOE must enforce the partitioning of memory areas so that access of software to memory areas is controlled. Any restrictions are to be defined by the Smartcard Embedded Software. Thereby security violations caused by accidental or deliberate access to restricted data (which may include code) can be prevented (refer to T.Mem-Access). The threat T.Mem-Access is therefore removed if the objective is met.
- 160 The clarification of O.Mem-Access makes clear that it is up to the Smartcard Embedded Software to implement the memory management scheme by appropriately administrating the TSF. The TOE shall provide access control functions as a means to be used by the Smartcard Embedded Software. This is further emphasised by the clarification of the treatment of User Data of the Composite TOE(OE.Resp-AppI) which reminds that the Smartcard Embedded Software must not undermine the restrictions it defines. Therefore, the clarifications contribute to the coverage of the threat T.Mem-Access. .
- 161 Compared to Smartcard IC Platform Protection Profile a clarification has been made for the security objective “The treatment of User Data of the Composite TOE(OE.Resp-AppI)”: By definition cipher or plain text data and cryptographic keys are User Data. So, the Smartcard Embedded Software will protect such data if required and use keys and functions appropriately in order to ensure the strength of cryptographic operation. Quality and confidentiality must be maintained for keys that are imported and/or derived from other keys. This implies that appropriate key management has to be realised in the environment. That is expressed by the assumption A.Key – Function which is covered from OE.Resp-AppI. These measures make sure that the
-

assumption A.Resp-Appl is still covered by the security objective OE.Resp-Appl.

- 162 The organisational security policy Limitation of capability and blocking the Loader (P.Lim_Block_Loader) is directly implemented by the security objective for the TOE "Capability and availability of the Loader (O.Cap_Avail_Loader)" and the security objective for the TOE environment "Limitation of capability and blocking the Loader (OE.Lim_Block_Loader)". The TOE security objective "Capability and availability of the Loader" (O.Cap_Avail_Loader) mitigates also the threat "Abuse of Functionality" (T.Abuse-Func) if attacker tries to misuse the Loader functionality in order to manipulate security services of the TOE provided or depending on IC Dedicated Support Software or user data of the TOE as IC Embedded Software, TSF data or user data of the smartcard product.
- 163 The organisational security policy "Controlled usage to Loader Functionality (P.Ctrlr_Loader) is directly implemented by the security objective for the TOE "Access control and authenticity for the Loader (O.Ctrlr_Auth_Loader)" and the security objective for the TOE environment "Secure communication and usage of the Loader (OE.Loader_Usage)".
- 164 The threat "Masquerade the TOE (T.Masquerade_TOE)" is directly covered by the TOE security objective "Authentication to external entities (O.Authentication)" describing the proving part of the authentication and the security objective for the operational environment of the TOE "External entities authenticating of the TOE (OE.TOE_Auth)" verifying part of the authentication.
- 165 The justification related to the security objectives O.TDES, O.AES, O.RSA, O.ECDSA, O.ECDH and O.SHA is followings: Since these objectives require the TOE to implement the same specific security functionality as required by P.Crypto-Service, the organization security policy is covered by the objective.
- 166 The threat "Diffusion of open samples" (T.Open_Samples_Diffusion) is directly covered by the TOE security objective "Protection of the confidentiality of the TSF" (O.Prot_TSF_Confidentiality) based on the self-protection of the TOE and the authentication mechanism of the Loader. Additionally to O.Prot_TSF_Confidentiality (Protection of the confidentiality of the TSF), T.Open_Samples_Diffusion threat is countered by O.Leak-Inherent (Protection against Inherent Information Leakage) and O.Leak-Forced (Protection against Forced Information Leakage) from the PP.

5 EXTENDED COMPONENTS DEFINITION

167 This chapter 5 Extended Components Definition contains the following sections:

5.1 Definition of the family FCS_RNG

5.2 Definition of the Family FMT_LIM

5.3 Definition of the Family FAU_SAS

5.4 Definition of the Family FDP_SDC

5.5 Definition of the Family FIA_API

5.1 Definition of the Family FCS_RNG

168 To define the IT security functional requirements of the TOE an additional family (FCS_RNG) of the Class FCS (cryptographic support) is defined here. This family describes the functional requirements for random number generation used for cryptographic purposes.

FCS_RNG Generation of Random Numbers

169 Family behaviour

170 This family defines quality requirements for the generation of random numbers which are intended to be used for cryptographic purposes.

171 Component levelling:

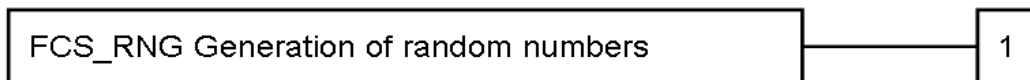

| | |
|------------------|--|
| FCS_RNG.1 | Generation of random numbers requires that random numbers meet a defined quality metric. |
| Management: | FCS_RNG.1 There are no management activities foreseen. |
| Audit: | FCS_RNG.1 There are no actions defined to be auditable. |
| FCS_RNG.1 | Random number generation |
| Hierarchical to: | No other components. |
| Dependencies: | No dependencies. |
| FCS_RNG.1.1 | The TSF shall provide a [selection: <i>physical, non-physical true, deterministic, hybrid physical, hybrid deterministic</i>] random number generator that implements: [assignment: <i>list of security capabilities</i>]. |
| FCS_RNG.1.2 | The TSF shall provide [selection: <i>bits, octets of bits, numbers</i> [assignment: <i>format of the numbers</i>]] that meet [assignment: <i>a defined quality metric</i>]. |

5.2 Definition of the Family FMT_LIM

172 To define the IT security functional requirements of the TOE an additional family (FMT_LIM) of the Class FMT (Security Management) is defined here. This family describes the functional requirements for the Test Features of the TOE. The new functional requirements were defined in the class FMT because this class addresses the management of functions of the TSF. The examples of the technical mechanism used in the

TOE appropriate to address the specific issues of preventing the abuse of functions by limiting the capabilities of the functions and by limiting their availability.

173 The family “Limited capabilities and availability (FMT_LIM)” is specified as follows.

FMT_LIM Limited capabilities and availability

Family behaviour

This family defines requirements that limit the capabilities and availability of functions in a combined manner. Note that FDP_ACF restricts the access to functions whereas the component Limited Capability of this family requires the functions themselves to be designed in a specific manner.

Component levelling:



FMT_LIM.1 Limited capabilities requires that the TSF is built to provide only the capabilities (perform action, gather information) necessary for its genuine purpose.

FMT_LIM.2 Limited availability requires that the TSF restrict the use of functions (refer to Limited capabilities (FMT_LIM.1)). This can be achieved, for instance, by removing or by disabling functions in a specific phase of the TOE's life-cycle.

Management: FMT_LIM.1, FMT_LIM.2

There are no management activities foreseen.

Audit: FMT_LIM.1, FMT_LIM.2

There are no actions defined to be auditable.

174 The TOE Functional Requirement “Limited capabilities (FMT_LIM.1)” is specified as follows.

FMT_LIM.1 Limited capabilities

Hierarchical to: No other components.

FMT_LIM.1.1 The TSF shall be designed and implemented in a manner that limits their capabilities so that in conjunction with “Limited availability (FMT_LIM.2)” the following policy is enforced [assignment: *Limited capability policy*].

Dependencies: FMT_LIM.2 Limited availability.

175 The TOE Functional Requirement “Limited availability (FMT_LIM.2)” is specified as follows.

| | |
|-------------------|--|
| FMT_LIM.2 | Limited availability |
| Hierarchical to: | No other components. |
| FMT_LIM.2.1 | The TSF shall be designed in a manner that limits its availability so that in conjunction with “Limited capabilities (FMT_LIM.1)” the following policy is enforced [assignment: <i>Limited availability policy</i>]. |
| Dependencies: | FMT_LIM.1 Limited capabilities. |
| Application note: | <p>The functional requirements FMT_LIM.1 and FMT_LIM.2 assume that there are two types of mechanisms (limitation of capabilities and limitation of availability) which together shall provide protection in order to enforce the same policy or two mutual supportive policies related to the same functionality. This allows e.g. that</p> <p>(i) the TSF is provided without restrictions in the product in its user environment but its capabilities are so limited that the policy is enforced</p> <p>or conversely</p> <p>(ii) the TSF is designed with high functionality but is removed or disabled in the product in its user environment.</p> |

5.3 Definition of the Family FAU_SAS

176 To define the security functional requirements of the TOE an additional family (FAU_SAS) of the Class FAU (Security Audit) is defined here. This family describes the functional requirements for the storage of audit data. It has a more general approach than FAU_GEN, because it does not necessarily require the data to be generated by the TOE itself and because it does not give specific details of the content of the audit records.

177 The family "Audit data storage (FAU_SAS)" is specified as follows.

FAU_SAS Audit data storage

Family behaviour

This family defines functional requirements for the storage of audit data.

Component levelling

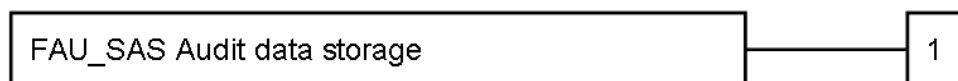

FAU_SAS.1 Requires the TOE to provide the possibility to store audit data.

Management: FAU_SAS.1

There are no management activities foreseen.

Audit: FAU_SAS.1

There are no actions defined to be auditable.

FAU_SAS.1 Audit storage

Hierarchical to: No other components.

FAU_SAS.1.1 The TSF shall provide [assignment: *list of subjects*] with the capability to store [assignment: *list of audit information*] in the [assignment: *type of persistent memory*].

Dependencies: No dependencies.

5.4 Definition of the Family FDP_SDC

- 178 To define the security functional requirements of the TOE an additional family (FDP_SDC.1) of the Class FDP (User data protection) is defined here.
- 179 The family "Stored data confidentiality (FDP_SDC)" is specified as follows.

FDP_SDC.1 Stored data confidentiality

Family behavior

This family provides requirements that address protection of user data confidentiality while these data are stored within memory areas protected by the TSF. The TSF provides access to the data in the memory through the specified interfaces only and prevents compromise of their information bypassing these interfaces. It complements the family "Stored data integrity (FDP_SDI)" which protects the user data from integrity errors while being stored in the memory.

Component leveling



- 180 FDP_SDC.1 Requires the TOE to protect the confidentiality of information of the user data in specified memory areas.

Management: FDP_SDC.1.

There are no management activities foreseen.

Audit: FDP_SDC.1

There are no actions defined to be auditable.

| | |
|------------------|--|
| FDP_SDC.1 | Stored data confidentiality |
| Hierarchical to: | No other components. |
| Dependencies: | No dependencies. |
| FDP_SDC.1.1 | The TSF shall ensure the confidentiality of the information of the user data while it is stored in the [assignment: <i>memory area</i>] |

5.5 Definition of the Family FIA_API

181 To describe the IT security functional requirements of the TOE a functional family FIA_API (Authentication Proof of Identity) of the Class FIA (Identification and authentication) is defined here. This family describes the functional requirements for the proof of the claimed identity by the TOE and enables the authentication verification by an external entity. The other families of the class FIA address the verification of the identity of an external entity by the TOE.

182 The other families of the Class FIA describe only the authentication verification of users' identity performed by the TOE and do not describe the functionality of the user to prove their identity. The following paragraph defines the family FIA_API in the style of the Common Criteria part 2 (cf. [3], chapter "Extended components definition (APE_ECD)") from a TOE point of view.

183 The family "Authentication Proof of Identity (FIA_API)" is specified as follows.

FIA_API.1 Authentication Proof of Identity

Family behaviour

184 This family defines functions provided by the TOE to prove its identity and to be verified by an external entity in the TOE IT environment.

Component levelling

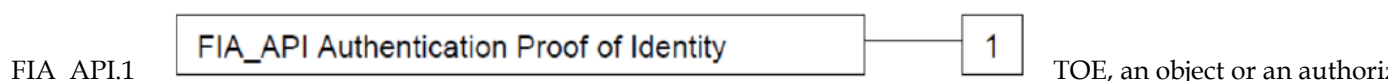

Management: FIA_API.1

The following actions could be considered for the management functions in FMT: Management of authentication information used to prove the claimed identity.

Audit: FIA_API.1

There are no actions defined to be auditable.

FIA_API.1 Authentication Proof of Identity

Hierarchical to: No other components.

Dependencies: No dependencies.

FIA_API.1.1

The TSF shall provide a [assignment: *authentication mechanism*] to prove the identity of the [selection: *TOE, [assignment: *object, authorized user or role*]*] to an external entity.

6 IT security requirements

185 This chapter 6 IT Security Requirements contains the following sections:

6.1 Security Functional Requirements for the TOE

6.2 Security Assurance Requirements for the TOE

6.3 Security Requirements Rationale

6.1 Security Functional Requirements for the TOE

186 In order to define the Security Functional Requirements the Part 2 of the Common Criteria was used. However, some Security Functional Requirements have been refined. The refinements are described below the associated SFR. The operations completed in the ST are marked in italic font.

6.1.1 Malfunctions

187 The TOE shall meet the requirement "Limited fault tolerance (FRU_FLT.2)" as specified below.

| | |
|--------------------|--|
| FRU_FLT.2 | Limited fault tolerance |
| Hierarchical to: | FRU_FLT.1 Degraded fault tolerance |
| FRU_FLT.2.1 | The TSF shall ensure the operation of all the TOE's capabilities when the following failures occur: <i>exposure to operating conditions which are not detected according to the requirement Failure with preservation of secure state (FPT_FLS.1).</i> |
| Dependencies: | FPT_FLS.1 Failure with preservation of secure state |
| Refinement: | The term "failure" above means "circumstances". The TOE prevents failures for the "circumstances" defined above. |
| Application Note : | Environmental conditions include but are not limited to power supply, clock, and other external signals (e.g. reset signal) necessary for the TOE operation. |

188 The TOE shall meet the requirement "Failure with preservation of secure state (FPT_FLS.1)" as specified below.

| | |
|-------------------|--|
| FPT_FLS.1 | Failure with preservation of secure state |
| Hierarchical to: | No other components. |
| FPT_FLS.1.1 | The TSF shall preserve a secure state when the following types of failures occur: <i>exposure to operating conditions which may not be tolerated according to the requirement Limited fault tolerance (FRU_FLT.2) and where therefore a malfunction could occur.</i> |
| Dependencies: | No dependencies |
| Refinement: | The term "failure" above also covers "circumstances". The TOE prevents failures for the "circumstances" defined above. |
| Application note: | The secure state is maintained by TOE's detectors. The TOE's detectors are monitoring the failure occurs. The failures are abnormal detectors that detect out of the specified range. If the failures are happen, the TOE goes into RESET state. This satisfies the FPT_FLS.1 "Failure with preservation of secure state." |

6.1.2 Abuse of Functionality

189 The TOE shall meet the requirement "Limited capabilities (FMT_LIM.1)" as specified below (Common Criteria Part 2 extended).

| | | |
|-----|---|---|
| | FMT_LIM.1 | Limited capabilities |
| | Hierarchical to: | No other components. |
| | FMT_LIM.1.1 | The TSF shall be designed and implemented in a manner that limits their capabilities so that in conjunction with “Limited availability (FMT_LIM.2)” the following policy is enforced: <i>Deploying Test Features after TOE Delivery does not allow user data of the Composite TOE to be disclosed or manipulated, TSF data to be disclosed or manipulated, software to be reconstructed and no substantial information about construction of TSF to be gathered which may enable other attacks.</i> |
| | Dependencies: | FMT_LIM.2 Limited availability. |
| 190 | The TOE shall meet the requirement “Limited availability (FMT_LIM.2)” as specified below (Common Criteria Part 2 extended). | |
| | FMT_LIM.2 | Limited availability |
| | Hierarchical to: | No other components. |
| | FMT_LIM.2.1 | The TSF shall be designed in a manner that limits their availability so that in conjunction with “Limited capabilities (FMT_LIM.1)” the following policy is enforced: <i>Deploying Test Features after TOE Delivery does not allow user data of the Composite TOE to be disclosed or manipulated, TSF data to be disclosed or manipulated, software to be reconstructed and no substantial information about construction of TSF to be gathered which may enable other attacks.</i> |
| | Dependencies: | FMT_LIM.1 Limited capabilities. |
| 191 | The TOE shall meet the requirement “Audit storage (FAU_SAS.1)” as specified below (Common Criteria Part 2 extended). | |
| | FAU_SAS.1 | Audit storage |
| | Hierarchical to: | No other components. |
| | FAU_SAS.1.1 | The TSF shall provide <i>the test process before TOE Delivery</i> with the capability to store <i>the Initialisation Data and/or Prepersonalisation Data and/or supplements of the Smartcard Embedded Software in the Test ROM area.</i> |
| | Dependencies: | No dependencies. |
| | Application Note: | The integrity and uniqueness of the unique identification of the TOE must be supported by the development, production and test environment. |

6.1.3 Physical Manipulation and Probing

192 The TOE shall meet the requirement “Stored data confidentiality (FDP_SDC.1)” as specified below.

| | | |
|--|------------------|-----------------------------|
| | FDP_SDC.1 | Stored data confidentiality |
| | Hierarchical to: | No other components. |

| | | |
|-----|--|---|
| | Dependencies: | No dependencies. |
| | FDP.SDC.1.1 | The TSF shall ensure the confidentiality of the information of the user data while it is stored in the <i>FLASH, RAM or ROM</i> . |
| 193 | The TOE shall meet the requirement “Stored data integrity monitoring and action (FDP_SDI.2)” as specified below. | |
| | FDP_SDI.2 | Stored data integrity monitoring and action |
| | Hierarchical to: | FDP_SDI.1 Stored data integrity monitoring |
| | Dependencies: | No dependencies. |
| | FDP_SDI.2.1 | The TSF shall monitor user data stored in containers controlled by the TSF for <i>error</i> on all objects, based on the following attributes: <i>FLASH, RAM or ROM read operation</i> . |
| | FDP_SDI.2.2 | Upon detection of a data integrity error, the TSF shall <i>enforce a device RESET or an interrupt</i> . |
| | Application Note: | This requirement is achieved by security features such internal encryption and scrambling mechanisms. |
| 194 | The TOE shall meet the requirement “Resistance to physical attack (FPT_PHP.3)” as specified below. | |
| | FPT_PHP.3 | Resistance to physical attack |
| | Hierarchical to: | No other components. |
| | FPT_PHP.3.1 | The TSF shall resist <i>physical manipulation and physical probing</i> to the TSF by responding automatically such that the SFRs are always enforced. |
| | Dependencies: | No dependencies. |
| | Refinement: | The TSF will implement appropriate mechanisms to continuously counter physical manipulation and physical probing. Due to the nature of these attacks (especially manipulation) the TSF can by no means detect attacks on all of its elements. Therefore, permanent protection against these attacks is required ensuring that security functional requirements are enforced. Hence, “automatic response” means here (i) assuming that there might be an attack at any time and (ii) countermeasures are provided at any time. |
| | Application Note: | This requirement is achieved by security feature as the shield must be removed and bypassed in order to perform physical intrusive attacks. The TOE makes appropriate secure reaction to stops operation if a physical manipulation or physical probing attack is detected. And also internal scrambling & encryption for memories and logic area make the reverse-engineering of the TOE layout |

unpractical. So these functionalities meet the security functional requirement of FPT_PHP.3: Resistance to physical attack.

6.1.4 Leakage

195 The TOE shall meet the requirement “Basic internal transfer protection (FDP_ITT.1)” as specified below.

FDP_ITT.1 Basic internal transfer protection

Hierarchical to: No other components.

FDP_ITT.1.1 The TSF shall enforce the *Data Processing Policy* to prevent the *disclosure* of user data when it is transmitted between physically-separated parts of the TOE.

Dependencies: [FDP_ACC.1 Subset access control, or FDP_IFC.1 Subset information flow control]

Refinement: The different memories, the CPU and other functional units of the TOE (e.g. a cryptographic co-processor) are seen as physically-separated parts of the TOE.

196 The TOE shall meet the requirement “Basic internal TSF data transfer protection (FPT_ITT.1)” as specified below.

FPT_ITT.1 Basic internal TSF data transfer protection

Hierarchical to: No other components.

FPT_ITT.1.1 The TSF shall protect TSF data from *disclosure* when it is transmitted between separate parts of the TOE.

Dependencies: No dependencies.

Refinement: The different memories, the CPU and other functional units of the TOE (e.g. a cryptographic co-processor) are seen as separated parts of the TOE.

This requirement is equivalent to FDP_ITT.1 above but refers to TSF data instead of user data. Therefore, it should be understood as to refer to the same *Data Processing Policy* defined under FDP_IFC.1 below.

197 The TOE shall meet the requirement “Subset information flow control (FDP_IFC.1)” as specified below:

FDP_IFC.1 **Subset information flow control**

Hierarchical to: No other components.

FDP_IFC.1.1 The TSF shall enforce the *Data Processing Policy* on all confidential data when they are processed or transferred by the TOE or by the Security IC Embedded Software.

Dependencies: FDP_IFF.1 Simple security attributes

198 The following Security Function Policy (SFP) Data Processing Policy is defined for the requirement “Subset information flow control (FDP_IFC.1)”:

User data of the Composite TOE and TSF data shall not be accessible from the TOE except when the Security IC Embedded Software decides to communicate the user data of the Composite TOE via an external interface. The protection shall be applied to confidential data only but without the distinction of

attributes controlled by the Security IC Embedded Software.

6.1.5 Random Numbers (DTRNG FRO M)

- 199 The TOE shall meet the requirement “Quality metric for random numbers (FCS_RNG.1)” as specified below (Common Criteria Part 2 extended).

FCS_RNG.1/PTG.2 Random number generation - PTG.2

Hierarchical to: No other components.

FCS_RNG.1.1/PTG.2 The TSF shall provide a *physical* random number generator that implements:

(PTG.2.1) *A total failure test detects a total failure of entropy source immediately when the RNG has started. When a total failure is detected, no random numbers will be output.*

(PTG.2.2) *If a total failure of the entropy source occurs while the RNG is being operated, the RNG prevents the output of any internal random number that depends on some raw random numbers that have been generated after the total failure of the entropy source*

(PTG.2.3) *The online test shall detect non-tolerable statistical defects of the raw random number sequence (i) immediately when the RNG has started, and (ii) while the RNG is being operated. The TSF must not output any random numbers before the power-up online test has finished successfully or when a defect has been detected.*

(PTG.2.4) *The online test procedure shall be effective to detect non-tolerable weaknesses of the random numbers soon.*

(PTG.2.5) *The online test procedure checks the quality of the raw random number sequence. It is triggered at regular intervals or continuously. The online test is suitable for detecting non-tolerable statistical defects of the statistical properties of the raw random numbers within an acceptable period of time*

FCS_RNG.1.2/PTG.2 The TSF shall provide numbers, 16-bit per number that meet:

(PTG.2.6) *Test procedure A does not distinguish the internal random numbers from output sequences of an ideal RNG.*

(PTG.2.7) *The average Shannon entropy per internal random bit exceeds 0.997*

Application Note: The DTRNG FRO M library comprises some functions that perform statistical tests on the DTRNG FRO M output in order to execute so-called total-failure test and online test. The online test function triggers a set of statistical tests embedded in a logic block connecting to DTRNG FRO M hardware directly, Upon completing the statistical tests, the logic block shall notify embedded software of the test result. The total-failure test is implemented in pure software. If either test fails, the function returns an error value and the DTRNG FRO M is shut down. Those functions are described in DTRNG FRO M Application note in detail and are available to embedded software.

Dependencies: No dependencies

FCS_RNG.1/RGS-IC Random number generation – RGS-IC

Hierarchical to: No other components.

FCS_RNG.1.1/RGS-IC The TSF shall provide a *physical* random number generator that implements:
 - the rules RègleArchiGVA-1 and the recommendation RecomArchiGVA-1 of [21] ;
 - total failure tests and online tests.

FCS_RNG.1.2/RGS-IC The TSF shall provide *random numbers* that meet the rule RègleArchiGVA-2 of [21].

Dependencies: No dependencies.

Warning: The TSF fulfils some but not all the necessary rules to comply with [21] regarding random numbers generators (RNG). The composite product's RNG will comply with [21] only when all the rules of §2.4 "Génération d'aléa cryptographique" of [21] are addressed. In particular, a cryptographic post-processing must be implemented by the composite developer.

6.1.6 Memory Access Control

- 200 Usage of multiple applications in one Smartcard often requires separating code and data in order to prevent that one application can access code and/or data of another application. To support the TOE provides Area based Memory Access Control.
- 201 The security service being provided is described in the Security Function Policy (SFP) Memory Access Control Policy. The security functional requirement "Subset access control (FDP_ACC.1)" requires that this policy is in place and defines the scope were it applies. The security functional requirement "Security attribute based access control (FDP_ACF.1)" defines addresses security attribute usage and characteristics of policies. It describes the rules for the function that implements the Security Function Policy (SFP) as identified in FDP_ACC.1. The decision whether an access is permitted or not is taken based upon attributes allocated to the software. The user software defines the attributes and memory areas. The corresponding permission control information is evaluated "on-the-fly" by the hardware so that access is granted/effective or denied/inoperable.
- 202 The security functional requirement "Static attribute initialization (FMT_MSA.3)" ensures that the default values of security attributes are appropriately either permissive or restrictive in nature. Alternative values can be specified by any subject provided that the Memory Access Control Policy allows that. This is described by the security functional requirement "Management of security attributes (FMT_MSA.1)". The attributes are determined during TOE manufacturing (FMT_MSA.3) or set at run-time (FMT_MSA.1).
- 203 From TOE's point of view the different roles in the user software can be distinguished according to the memory based access control. However the definition of the roles belongs to the user software.
- 204 The following Security Function Policy (SFP) Memory Access Control Policy is defined for the requirement "Security attribute based access control (FDP_ACF.1)":

Memory Access Control Policy

The TOE shall control read, write, delete, and execute accesses of software running at between two different modes (privilege and user mode) on data including code stored in memory areas.

The TOE shall restrict the ability to define, to change or at least to finally accept the applied rules (as mentioned in FDP_ACF.1) to software with privilege mode).

205 The TOE shall meet the requirement “Subset access control (FDP_ACC.1)” as specified below.

FDP_ACC.1 Subset access control

Hierarchical to: No other components.

FDP_ACC.1.1 The TSF shall enforce the *Memory Access Control Policy* on all subjects (software with privilege mode and user mode), all objects (data including code stored in memories) and all the operations defined in the *Memory Access Control Policy*.

Subjects are software codes in Privilege and User mode.

Objects are data stored in ROM, RAM and FLASH memories.

Dependencies: FDP_ACF.1 Security attribute based access control

The TOE shall meet the requirement “Security attribute based access control (FDP_ACF.1)” as specified below.

FDP_ACF.1 Security attribute based access control

The attributes are all the operations related to the data stored in memories, which are *the read, write and execute operations*.

Hierarchical to: No other components.

FDP_ACF.1.1 The TSF shall enforce the *Memory Access Control Policy* to objects based on the following: *memory area where the software is executed from and/or the memory area where the access is performed to and/or the operation to be performed*.

FDP_ACF.1.2 The TSF shall enforce the following rules to determine if an operation among controlled subjects and controlled objects is allowed: *evaluate the corresponding permission control information before the access so that accesses to be denied cannot be utilised by the subject attempting to perform the operation*.

FDP_ACF.1.3 The TSF shall explicitly authorise access of subjects to objects based on the following additional rules: *none*.

FDP_ACF.1.4 The TSF shall explicitly deny access of subjects to objects based on the following additional rules: *none*.

Dependencies: FDP_ACC.1 Subset access control
FMT_MSA.3 Static attribute initialisation

The TOE shall meet the requirement “Static attribute initialisation (FMT_MSA.3)” as specified below.

FMT_MSA.3 Static attribute initialisation

Hierarchical to: No other components.

| | |
|------------------|--|
| FMT_MSA.3.1 | The TSF shall enforce the <i>Memory Access Control Policy</i> to provide <i>well defined</i> default values for security attributes that are used to enforce the SFP. |
| FMT_MSA.3.2 | The TSF shall allow any <i>subject (provided that the Memory Access Control Policy is enforced and the necessary access is therefore allowed)</i> to specify alternative initial values to override the default values when an object or information is created. |
| Dependencies: | FMT_MSA.1 Management of security attributes FMT_SMR.1 Security roles |
| 206 | The TOE shall meet the requirement “Management of security attributes (FMT_MSA.1)” as specified below: |
| FMT_MSA.1 | Management of security attributes |
| Hierarchical to: | No other components. |
| FMT_MSA.1.1 | The TSF shall enforce the <i>Memory Access Control Policy</i> to restrict the ability to <i>change default, modify or delete</i> the security attributes <i>permission control information to running at privilege mode</i> . |
| Dependencies: | [FDP_ACC.1 Subset access control or FDP_IFC.1 Subset information flow control] FMT_SMF.1 Specification of management functions FMT_SMR.1 Security roles |
| 207 | The TOE shall meet the requirement “Specification of management functions (FMT_SMF.1)” as specified below: |
| FMT_SMF.1 | Specification of management functions |
| Hierarchical to: | No other components |
| FMT_SMF.1.1 | The TSF shall be capable of performing the following security management functions: <i>access the control registers of the MPU</i> . |
| Dependencies: | No dependencies |

6.1.7 Cryptographic Support

- 208 FCS_COP.1 Cryptographic operation requires, a cryptographic operation to be performed in accordance with a specified algorithm and with a cryptographic key of specified sizes. The specified algorithm and cryptographic key sizes can be based on an assigned standard.
- 209 The following additional specific security functionality is implemented in the TOE:
- Triple Data Encryption Standard (TDES) with 112bit or 168bit key size
 - Advanced Encryption Standard (AES) with 128 bit, 192bit and 256bit key size
 - Rivest-Shamir-Adleman (RSA) public key asymmetric cryptography, with key size 1280-bit up to 2048-bit with a granularity of 2 bits (optional)
 - Elliptic Curve Cryptography (ECC) (optional)

- Secure Hash Algorithm (SHA) (optional)

6.1.8 Triple-DES Operation

- 210 The Triple DES (TDES) operation of the TOE shall meet the requirement “Cryptographic operation (FCS_COP.1)” as specified below.

FCS_COP.1/TDES Cryptographic operation – TDES

Hierarchical to: No other components.

FCS_COP.1.1/TDES The TSF shall perform *encryption and decryption* in accordance with a specified cryptographic algorithm *Triple Data Encryption Standard (TDES) - ECB mode* and cryptographic key sizes *112 bit or 168 bit key size* that meet the following: [FIPS SP800-67], chapter 2 and 3. TOE implements TDES with key option 1 and 2 with ECB mode.

Dependencies: [FDP_ITC.1 Import of user data without security attributes or FDP_ITC.2 Import of user data with security attributes, or FCS_CKM.1 Cryptographic key generation]
FCS_CKM.4 Cryptographic key destruction

6.1.9 AES Operation

- 211 The AES operation of the TOE shall meet the requirement “Cryptographic operation (FCS_COP.1)” as specified below.

FCS_COP.1/AES Cryptographic operation – AES

Hierarchical to: No other components.

FCS_COP.1.1/AES The TSF shall perform *encryption and decryption* in accordance with a specified cryptographic algorithm *Advanced Encryption Standard (AES) - ECB mode* and cryptographic key sizes *128bit, 192bit or 256bit key size* that meet the following: [FIPS197], chapter 5.

Dependencies: [FDP_ITC.1 Import of user data without security attributes or FDP_ITC.2 Import of user data with security attributes or FCS_CKM.1 Cryptographic key generation]
FCS_CKM.4 Cryptographic key destruction

6.1.10 Rivest-Shamir-Adleman (RSA) Operation (optional)

The RSA/ECC/SHA cryptographic library of the TOE shall meet the requirement “Cryptographic operation (FCS_COP.1)” as specified below.

FCS_COP.1/RSA Cryptographic operation

Hierarchical to: No other components

FCS_COP.1.1/RSA The TSF shall perform *the modular exponentiation part of RSA signature generation and verification* in accordance with a specified cryptographic algorithm *Rivest-Shamir-Adleman (RSA:standard RSA and RSA-CRT)* and cryptographic key sizes *from 1280-bit up to 2048-bit with 2-bit granularity* that meet the following standard: [ISO/IEC14888-2:2008]] *section 6.2 and 6.3.*

Dependencies: [FDP_ITC.1 Import of user data without security attributes or
FDP_ITC.2 Import of user data with security attributes, or
FCS_CKM.1 Cryptographic key generation]
FCS_CKM.4 Cryptographic key destruction

6.1.11 Rivest-Shamir-Adleman (RSA) Key Generation (optional)

The RSA key generation for the RSA/ECC/SHA library shall meet the requirement “Cryptographic key generation (FCS_CKM.1)” as specified below.

FCS_CKM.1/RSA Cryptographic key generation

Hierarchical to: No other components

FCS_CKM.1.1/RSA The TSF shall generate cryptographic keys in accordance with the specified cryptographic key generation algorithm *RSA* and with the specified cryptographic key sizes *from 1280-bit up to 2048-bit with 2-bit granularity* that meet the following: [ETSI TS 102 176-1], *section 6.2.2.1 Key and parameter generation algorithm rsagen1 and [ISO 18032], Incremental search.*

Dependencies: [FCS_CKM.2 Cryptographic key distribution or
FCS_COP.1 Cryptographic operation]
FCS_CKM.4 Cryptographic key destruction

Note 1) The RSA cryptographic key generation of the TOE generates two primes P and Q with the equal bit length, while the standard recommends to generate two primes P and Q such that $0.1 < |\log_2(P) - \log_2(Q)| < 30$.

Note 2) While the standard specifies that the private exponent D should be larger than the square root of the RSA modulus, i.e. $D > \sqrt{N}$, this verification is not performed by the RSA cryptographic key generation of the TOE.

Note 3) The RSA cryptographic key generation of the TOE performs a number of Miller-Rabin tests to ensure that the probability that the generated prime candidate is not a prime is below $2^{-(100)}$.

6.1.12 Elliptic Curve DSA Operation (optional)

The ECC library of the TOE shall meet the requirement “Cryptographic operation (FCS_COP.1)” as specified below.

| | |
|-------------------|---|
| FCS_COP.1/ECDSA | Cryptographic operation |
| Hierarchical to: | No other components |
| FCS_COP.1.1/ECDSA | The TSF shall perform <i>the signature generation/verification</i> in accordance with the specified cryptographic algorithm <i>ECDSA</i> and cryptographic key sizes <i>from 192-bit up to 512-bit</i> that meet the following standard: [ANS X9.62] , section 7.3 <i>Signing Process and section 7.4 Verifying Process</i> . |
| Dependencies: | [FDP_ITC.1 Import of user data without security attributes or FDP_ITC.2 Import of user data with security attributes, or FCS_CKM.1 Cryptographic key generation] FCS_CKM.4 Cryptographic key destruction |

Note1) The RSA/ECC/SHA library supports any valid curves over prime fields of size from 192-bit to 512-bit. However standard curves listed below whose security has been proven are in the scope of this evaluation. 1) [NIST curves]: Curves P-192, P-224, P-256, P-384 2) [Brainpool curves]: brainpoolP192r1, brainpoolP192t1, brainpoolP224r1, brainpoolP224t1, brainpoolP256r1, brainpoolP256t1, brainpoolP320r1, brainpoolP320t1, brainpoolP384r1, brainpoolP384t1, brainpoolP512r1, brainpoolP512t1, 3) [SEC-recommended curves]: secp192k1, secp192r1, secp224k1, secp224r1, secp256k1, secp256r1, secp384r1

6.1.13 Elliptic Curve DSA Key Generation (optional)

The key generation for the ECC library shall meet the requirement “Cryptographic key generation (FCS_CKM.1)” as specified below.

| | |
|-------------------|---|
| FCS_CKM.1/ECDSA | Cryptographic key generation |
| Hierarchical to: | No other components |
| FCS_CKM.1.1/ECDSA | The TSF shall generate cryptographic keys in accordance with the cryptographic key generation algorithm <i>ECC</i> and with the cryptographic key sizes <i>from 192-bit up to 512-bit</i> that meet the following standard: [ANS X9.62], section A.4.3 <i>Elliptic Curve Key Generation</i> . |
| Dependencies: | [FCS_CKM.2 Cryptographic key distribution or FCS_COP.1 Cryptographic operation] FCS_CKM.4 Cryptographic key destruction |

Note1) The RSA/ECC/SHA library supports any valid curves over prime fields of size from 192-bit to 512-bit. However standard curves listed below whose security has been proven are in the scope of this evaluation. 1) [NIST curves]: Curves P-192, P-224, P-256, P-384 2) [Brainpool curves]: brainpoolP192r1, brainpoolP192t1, brainpoolP224r1, brainpoolP224t1, brainpoolP256r1, brainpoolP256t1, brainpoolP320r1, brainpoolP320t1, brainpoolP384r1, brainpoolP384t1, brainpoolP512r1, brainpoolP512t1, 3)

[SEC-recommended curves]: secp192k1, secp192r1, secp224k1, secp224r1, secp256k1, secp256r1, secp384r1

6.1.14 Elliptic Curve Diffie-Hellman (ECDH) Key Agreement (optional)

The ECC library of the TOE shall meet the requirement “Cryptographic operation (FCS_COP.1)” as specified below.

FCS_COP.1/ECDH Cryptographic operation

Hierarchical to: No other components

FCS_COP.1.1/ECDH The TSF shall perform *the key exchange* in accordance with the specified cryptographic algorithm *ECDH* and cryptographic key sizes *from 192-bit up to 512-bit* that meet the following standard: [ANS X9.63], section 5.4.1 *Standard Diffie-Hellman primitive*.

Dependencies: [FDP_ITC.1 Import of user data without security attributes or FDP_ITC.2 Import of user data with security attributes, or FCS_CKM.1 Cryptographic key generation] FCS_CKM.4 Cryptographic key destruction

Note1) The RSA/ECC/SHA library supports any valid curves over prime fields of size from 192-bit to 512-bit. However standard curves listed below whose security has been proven are in the scope of this evaluation. 1) [NIST curves]: Curves P-192, P-224, P-256, P-384 2) [Brainpool curves]: brainpoolP192r1, brainpoolP192t1, brainpoolP224r1, brainpoolP224t1, brainpoolP256r1, brainpoolP256t1, brainpoolP320r1, brainpoolP320t1, brainpoolP384r1, brainpoolP384t1, brainpoolP512r1, brainpoolP512t1, 3)[SEC-recommended curves]: secp192k1, secp192r1, secp224k1, secp224r1, secp256k1, secp256r1, secp384r1

Note2) The implemented routines can be used with ephemeral or static private keys. The base point is assumed to be public.

Note3) For full compatibility, the user is responsible to perform step 2 of [ANS X9.63], section 5.2.2.1, prior to using the ECDH_generate function.

6.1.15 Secure Hash Algorithm (SHA) (optional)

The Secure Hash Algorithm (SHA) of the TOE shall meet the requirement “Cryptographic operation (FCS_COP.1)” as specified below.

FCS_COP.1/SHA Cryptographic operation

Hierarchical to: No other components

FCS_COP.1.1/SHA The TSF shall perform *secure hash computation* in accordance with a specified cryptographic algorithm *SHA224, SHA256, SHA384 and SHA512* and cryptographic key sizes *none* that meet the following standard: [FIPS PUB 180-3].

Note1) The AT1 Secure libraries provides the functionalities for computation of hash values. The use of these functionalities for keyed hash operations like HMAC or similar, is not subject of this TOE and requires specific security improvements and DPA analysis by the operating system which is not part of the TOE. The SHA224, SHA256, SHA384 and SHA512 functionalities are intended to be used for ECDSA signature generation and verification.

Note2) The TOE offers the functionality of hash value computation using SHA-1, SHA-224, SHA-256, SHA-384 and SHA-512. However, only the functions related to SHA-224, SHA-256, SHA-384 and SHA-512 is in the scope of this evaluation and is intended to be used for signature generation and verification. Note that neither of the functions must be used to hash secret values. In addition, the user is responsible for the truncation or padding of the hash value as required by step e), section 7.3 and step c), section 7.4.1 of the standard cited above.

Dependencies: [FDP_ITC.1 Import of user data without security attributes or
FDP_ITC.2 Import of user data with security attributes, or
FCS_CKM.1 Cryptographic key generation]
FCS_CKM.4 Cryptographic key destruction

6.1.16 Bootloader

The TOE Functional Requirement “Limited capabilities – Loader(FMT_LIM.1/Loader)” is specified as follows.

FMT_LIM.1/Loader Limited capabilities

Dependencies: FMT_LIM.2 Limited availability.

Hierarchical to: No other components.

FMT_LIM.1.1/Loader The TSF shall be designed and implemented in a manner that limits its capabilities so that in conjunction with “Limited availability (FMT_LIM.2)” the following policy is enforced: *Deploying Loader functionality after locking the chip to FLASH booting mode does not allow stored user data to be disclosed or manipulated by unauthorized user.*

The TOE Functional Requirement “Limited availability – Loader (FMT_LIM.2/Loader)” is specified as follows.

FMT_LIM.2/Loader Limited availability - Loader

Hierarchical to: No other components.

FMT_LIM.2.1/Loader The TSF shall be designed in a manner that limits its availability so that in conjunction with “Limited capabilities (FMT_LIM.1)” the following policy is

enforced: *The TSF prevents deploying the Loader functionality after locking the chip to FLASH booting mode.*

Dependencies: FMT_LIM.1 Limited capabilities.

The TOE Functional Requirement “Inter-TSF trusted channel (FTP_ITC.1)” is specified as follows.

FTP_ITC.1 Inter-TSF trusted channel

Hierarchical to: No other components.

FTP_ITC.1.1 The TSF shall provide a communication channel between itself and *the authorized user* that is logically distinct from other communication channels and provides assured identification of its end points and protection of the channel data from modification or disclosure.

FTP_ITC.1.2 The TSF shall permit *another trusted IT product* to initiate communication via the trusted channel.

FTP_ITC.1.3 The TSF shall initiate communication via the trusted channel for *deploying Loader mutual Authentication and establishment of session keys.*

Dependencies: No dependencies.

The TOE Functional Requirement “Basic data exchange confidentiality (FDP_UCT.1)” is specified as follows.

FDP_UCT.1 Basic data exchange confidentiality

Hierarchical to: No other components.

FDP_UCT.1.1 The TSF shall enforce the *Loader SFP to receive* user data in a manner protected from unauthorised disclosure.

Dependencies: [FTP_ITC.1 Inter-TSF trusted channel, or FTP_TRP.1 Trusted path] [FDP_ACC.1 Subset access control, or FDP_IFC.1 Subset information flow control]

The TOE Functional Requirement “Data exchange integrity (FDP_UIT.1)” is specified as follows.

FDP_UIT.1 Data exchange integrity

Hierarchical to: No other components.

Dependencies: [FTP_ITC.1 Inter-TSF trusted channel, or FTP_TRP.1 Trusted path] [FDP_ACC.1 Subset access control, or FDP_IFC.1 Subset information flow control]

- FDP_UIT.1.1 The TSF shall enforce the *Loader SFP* to *receive* user data in a manner protected from *modification, deletion, insertion* errors.
- FDP_UIT.1.2 The TSF shall be able to determine on receipt of user data, whether *modification, deletion, insertion* has occurred.

The TOE Functional Requirement “Subset access control - Loader (FDP_ACC.1/Loader)” is specified as follows.

FDP_ACC.1/ Loader Subset access control - Loader

Hierarchical to: No other components.

FDP_ACC.1.1/ Loader The TSF shall enforce the *Loader SFP* on

- (1) *the subjects Loader authorized users,*
- (2) *the objects user data in FLASH or ROM*
- (3) *the operation deployment of Loader*

Dependencies: FDP_ACF.1 Security attribute based access control.

Application Note: The TOE enforces the Loader SFP by FDP_ITC.1, FDP_UCT.1, FDP_UIT.1 and FDP_ACF.1 to describe additional access control rules

The TOE Functional Requirement “Security attribute based access control - Loader (FDP_ACF.1/Loader)” is specified as follows.

FDP_ACF.1/ Loader Security attribute based access control - Loader

Hierarchical to: No other components.

Dependencies: FMT_MSA.3 Static attribute initialization.

FDP_ACF.1.1/ Loader The TSF shall enforce the *Loader SFP* to objects based on the following:

- (1) *the subjects Loader authorized users with security attributes FLASH write.*
- (2) *the objects user data in FLASH with security attributes FLASH write.*

FDP_ACF.1.2/ Loader The TSF shall enforce the following rules to determine if an operation among controlled subjects and controlled objects is allowed: *Bootloader can do write operation in FLASH after a successful Authentication.*

FDP_ACF.1.3/ Loader The TSF shall explicitly authorize access of subjects to objects based on the following additional rules: *FLASH can be controlled based on security attributes , which can be limited by Bootloader APDU command.*

FDP_ACF.1.4/ Loader The TSF shall explicitly deny access of subjects to objects based on the following additional rules: *Bootloader cannot access the FLASH without successful authentication.*

6.1.17 Authentication Proof of Identity

The TOE shall meet the requirement "Authentication Proof of Identity (FIA_API.1)" as specified below.

FIA_API.1 Authentication Proof of Identity

Hierarchical to: No other components

Dependencies: No dependencies.

FIA_API.1.1 The TSF shall provide a *mutual authentication of Bootloader* to prove the identity of the TOE to an external entity

6.1.18 Summary of Security Functional Requirements

| Security Functional Requirements |
|---|
| Limited fault tolerance (FRU_FLT.2) |
| Failure with preservation of secure state (FPT_FLS.1) |
| Audit storage (FAU_SAS.1) |
| Stored data confidentiality (FDP_SDC.1) |
| Stored data integrity monitoring and action (FDP_SDI.2) |
| Limited capabilities(FMT_LIM.1) |
| Limited availability (FMT_LIM.2) |
| Resistance to physical attack (FPT_PHP.3) |
| Basic internal transfer protection (FDP_ITT.1) |
| Basic internal TSF data transfer protection (FPT_ITT.1) |
| Subset information flow control (FDP_IFC.1) |
| Authentication Proof of Identity (FIA_API.1) |
| Limited capabilities(FMT_LIM.1/Loader) |
| Limited availability - Loader(FMT_LIM.2/Loader) |
| Inter-TSF trusted channel (FTP_ITC.1) |
| Basic data exchange confidentiality (FDP_UCT.1) |
| Data exchange integrity (FDP_UIT.1) |
| Subset access control - Loader (FDP_ACC.1/ Loader) |
| Security attribute based access control - Loader (FDP_ACF.1/Loader) |
| Quality metric for random numbers (FCS_RNG.1/RGS-IC) |
| Random number generation - PTG.2(FCS_RNG.1/PTG.2) |

Table 5 Security Functional Requirements defined in Smart Card IC Protection Profile

| Security Functional Requirements |
|--|
| Subset access control (FDP_ACC.1) |
| Security attribute based access control (FDP_ACF.1) |
| Static attribute initialization (FMT_MSA.3) |
| Management of security attributes (FMT_MSA.1) |
| Specification of management functions (FMT_SMF.1) |
| Cryptographic operation (FCS_COP.1/TDES) |
| Cryptographic operation (FCS_COP.1/AES) |
| Cryptographic operation (FCS_COP.1/RSA) (optional) |
| Cryptographic key generation (FCS_CKM.1/ RSA) (optional) |
| Cryptographic operation (FCS_COP.1/ECDSA) (optional) |
| Cryptographic operation (FCS_COP.1/ECDH) (optional) |
| Cryptographic key generation (FCS_CKM.1/ ECDSA) (optional) |
| Cryptographic key generation (FCS_COP.1/SHA) (optional) |

Table 6 Augmented Security Functional Requirements

6.2 TOE Assurance Requirements

The Security Target will be evaluated according to

Security Target evaluation (Class ASE)

The TOE Assurance Requirements for the evaluation of the TOE and its development and operating environment are those taken from the

Evaluation Assurance Level 6 (EAL6)

and augmented by the following components

ASE_TSS.2

corresponding to level "EAL6+".

All refinements from *Protection Profile BSI-PP-0084 version 1.0* for the assurance requirements (ALC_DEL, ALC_DVS, ALC_CMS, ALC_CMC, ADV_ARC, ADV_FSP, ADV_IMP, ATE_COV, AGD_OPE, AGD_PRE and AVA_VAN) have to be taken into consideration. In particular the document [13] is used in the context of vulnerability analysis

Class ADV: Development

| | |
|-------------------------------|-------------|
| Architectural design | (ADV_ARC.1) |
| Functional Specification | (ADV_FSP.5) |
| Implementation Representation | (ADV_IMP.2) |
| TSF Internals | (ADV_INT.3) |
| TOE Design | (ADV_TDS.5) |
| Security Policy Model | (ADV_SPM.1) |

Class AGD: Guidance documents activities

| | |
|---------------------------|-------------|
| Operational User Guidance | (AGD_OPE.1) |
| Preparative procedures | (AGD_PRE.1) |

Class ALC: Life-cycle support

| | |
|-----------------------------|--------------------|
| CM Capabilities | (ALC_CMC.5) |
| CM Scope | (ALC_CMS.5) |
| Delivery | (ALC_DEL.1) |
| <u>Development Security</u> | <u>(ALC_DVS.2)</u> |
| Life Cycle Definition | (ALC_LCD.1) |
| Tools and Techniques | (ALC_TAT.3) |

Class ASE: Security Target evaluation

| | |
|--------------------------------|-------------|
| Conformance claims | (ASE_CCL.1) |
| Extended components definition | (ASE_ECD.1) |
| ST introduction | (ASE_INT.1) |
| Security objectives | (ASE_OBJ.2) |
| Derived security requirements | (ASE_REQ.2) |
| Security problem definition | (ASE_SPD.1) |
| TOE summary specification | (ASE_TSS.2) |

Class ATE: Tests

- Coverage (ATE_COV.3)
- Depth (ATE_DPT.3)
- Functional Tests (ATE_FUN.2)
- Independent Testing (ATE_IND.2)

Class AVA: Vulnerability assessment

- Vulnerability Analysis (AVA_VAN.5)

6.3 Security Requirements Rationale

6.3.1 Rationale for the Security Functional Requirements

212 Table 7 below gives an overview, how the security functional requirements are combined to meet the security objectives. The detailed justification follows after the table.

| Objective | TOE Security Functional and Assurance Requirements |
|---------------------|--|
| O.Leak-Inherent | <ul style="list-style-type: none"> - FDP_ITT.1 "Basic internal transfer protection" - FPT_ITT.1 "Basic internal TSF data transfer protection" - FDP_IFC.1 "Subset information flow control" - AVA_VAN.5 "Advanced methodical vulnerability analysis" |
| O.Phys-Probing | <ul style="list-style-type: none"> - FDP_SDC.1 "Stored data confidentiality" - FPT_PHP.3 "Resistance to physical attack" |
| O.Malfunction | <ul style="list-style-type: none"> - FRU_FLT.2 "Limited fault tolerance" - FPT_FLS.1 "Failure with preservation of secure state" - ADV_ARC.1 "Architectural Design with domain separation and non-bypassability" |
| O.Phys-Manipulation | <ul style="list-style-type: none"> - FDP_SDI.2 "Stored data integrity monitoring and action" - FPT_PHP.3 "Resistance to physical attack" |
| O.Leak-Forced | <p>All requirements listed for O.Leak-Inherent</p> <ul style="list-style-type: none"> - FDP_ITT.1, FPT_ITT.1, FDP_IFC.1, AVA_VAN.5 <p>plus those listed for O.Malfunction and O.Phys-Manipulation</p> <ul style="list-style-type: none"> - FRU_FLT.2, FPT_FLS.1, FPT_PHP.3, ADV_ARC.1 |
| O.Abuse-Func | <ul style="list-style-type: none"> - FMT_LIM.1 "Limited capabilities" - FMT_LIM.2 "Limited availability" <p>plus those for O.Leak-Inherent, O.Phys-Probing, O.Malfunction, O.Phys-Manipulation, O.Leak-Forced</p> <ul style="list-style-type: none"> - FDP_ITT.1, FPT_ITT.1, FDP_IFC.1, FPT_PHP.3, FRU_FLT.2, FPT_FLS.1, ADV_ARC.1 |
| O.Identification | <ul style="list-style-type: none"> - FAU_SAS.1 "Audit storage" |
| O.RND | <ul style="list-style-type: none"> - FCS_RNG.1/PTG.2 "Quality metric for random numbers" and FCS_RNG.1/RGS-IC "Quality metric for random numbers" <p>plus those for O.Leak-Inherent, O.Phys-Probing, O.Malfunction, O.Phys-Manipulation, O.Leak-Forced</p> <ul style="list-style-type: none"> - FDP_ITT.1, FPT_ITT.1, FDP_IFC.1, FPT_PHP.3, FRU_FLT.2, FPT_FLS.1, AVA_VAN.5, ADV_ARC.1 |
| OE.Resp-Appl | not applicable |

| Objective | TOE Security Functional and Assurance Requirements |
|----------------------------|---|
| OE.Process-Sec-IC | not applicable |
| O.Mem-Access | - FDP_ACC.1 "Subset access control" - FDP_ACF.1 "Security attribute based access control" - FMT_MSA.3 "Static attribute initialisation" - FMT_MSA.1 "Management of security attributes" - FMT_SMF.1 "Specification of Management Functions" |
| O.TDES | - FCS_COP.1/TDES |
| O.AES | - FCS_COP.1/ AES |
| O.RSA | - FCS_COP.1/RSA - FCS_CKM.1/RSA |
| O.ECDSA | - FCS_COP.1/ ECDSA - FCS_CKM.1/ ECDSA |
| O.ECDH | - FCS_COP.1/ ECDH |
| O.SHA | - FCS_COP.1/SHA |
| O.Authentication | - FIA_API.1 " Authentication Proof of Identity" |
| OE.TOE_Auth | not applicable |
| O.Cap_Avail_Loader | - FMT_LIM.1/Loader "Limited capabilities" - FMT_LIM.2/Loader "Limited availability - Loader" |
| OE.Lim_Block_Loader | not applicable |
| O.Ctrl_Auth_Loader | - FTP_ITC.1 "Inter-TSF trusted channel" - FDP_UCT.1 "Basic data exchange confidentiality" - FDP_UIT.1 "Data exchange integrity" - FDP_ACC.1/Loader "Subset access control - Loader" - FDP_ACF.1/Loader "Security attribute based access control - Loader" |
| OE.Loader_Usage | not applicable |
| O.Prot_TSF_Confidentiality | - FDP_ACC.1/Loader "Subset access control - Loader" - FDP_ACF.1/Loader "Security attribute based access control - Loader" |

Table 7: Security Requirements versus Security Objectives

- 213 The justification related to the security objective "Protection against Inherent Information Leakage (O.Leak-Inherent)" is as follows:
- 214 The refinements of the security functional requirements FPT_ITT.1 and FDP_ITT.1 together with the policy statement in FDP_IFC.1 explicitly require the prevention of disclosure of secret data (TSF data as well as user data) when transmitted between separate parts of the TOE or while being processed. This includes that

attackers cannot reveal such data by measurements of emanations, power consumption or other behavior of the TOE while data are transmitted between or processed by TOE parts.

- 215 It is possible that the TOE needs additional support by the Security IC Embedded Software (e.g. timing attacks are possible if the processing time of algorithms implemented in the software depends on the content of secret). This support must be addressed in the Guidance Documentation. Together with this FPT_ITT.1, FDP_ITT.1 and FDP_IFC.1 are suitable to meet the objective.
- 216 The justification related to the security objective “Protection against Physical Probing (O.Phys-Probing)” is as follows:
- 217 The SFR FDP_SDC.1 requires the TSF to protect the confidentiality of the information of the user data stored in specified memory areas and prevent its compromise by physical attacks bypassing the specified interfaces for memory access. The scenario of physical probing as described for this objective is explicitly included in the assignment chosen for the physical tampering scenarios in FPT_PHP.3. Therefore, it is clear that this security functional requirement supports the objective.
- 218 It is possible that the TOE needs additional support by the Security IC Embedded Software (e. g. to send data over certain buses only with appropriate precautions). This support must be addressed in the Guidance Documentation. Together with this FPT_PHP.3 is suitable to meet the objective.
- 219 The justification related to the security objective “Protection against Malfunctions (O.Malfunction)” is as follows:
- 220 The definition of this objective shows that it covers a situation, where malfunction of the TOE might be caused by the operating conditions of the TOE (while direct manipulation of the TOE is covered O.Phys-Manipulation). There are two possibilities in this situation: Either the operating conditions are inside the tolerated range or at least one of them is outside of this range. The second case is covered by FPT_FLS.1, because it states that a secure state is preserved in this case. The first case is covered by FRU_FLT.2 because it states that the TOE operates correctly under normal (tolerated) conditions. The functions implementing FRU_FLT.2 and FPT_FLS.1 must work independently so that their operation cannot be affected by the Security IC Embedded Software (refer to the refinement). Therefore, there is no possible instance of conditions under O.Malfunction, which is not covered.
- 221 The justification related to the security objective “Protection against Physical Manipulation (O.Phys-Manipulation)” is as follows:
- 222 The SFR FDP_SDI.2 requires the TSF to detect the integrity errors of the stored user data and react in case of detected errors. The scenario of physical manipulation as described for this objective is explicitly included in the assignment chosen for the physical tampering scenarios in FPT_PHP.3. Therefore, it is clear that this security functional requirement supports the objective.
- 223 It is possible that the TOE needs additional support by the Embedded Software (for instance by implementing FDP_SDI.1 to check data integrity with the help of appropriate checksums, refer to Section 6.1). This support must be addressed in the Guidance Documentation. Together with this FPT_PHP.3 is suitable to meet the objective.
- 224 The justification related to the security objective “Protection against Forced Information Leakage (O.Leak-Forced)” is as follows:
- 225 This objective is directed against attacks, where an attacker wants to force an information leakage, which would not occur under normal conditions. In order to achieve this the attacker has to combine a first attack step, which modifies the behaviour of the TOE (either by exposing it to extreme operating conditions or by
-

directly manipulating it) with a second attack step measuring and analysing some output produced by the TOE. The first step is prevented by the same measures which support O.Malfunction and O.Phys-Manipulation, respectively. The requirements covering O.Leak-Inherent also support O.Leak-Forced because they prevent the attacker from being successful if he tries the second step directly.

- 226 The justification related to the security objective “Protection against Abuse of Functionality (O.Abuse-Func)” is as follows:
- 227 This objective states that abuse of functions (especially provided by the IC Dedicated Test Software, for instance in order to read secret data) must not be possible in Phase 7 of the life-cycle. There are two possibilities to achieve this: (i) They cannot be used by an attacker (i. e. its availability is limited) or (ii) using them would not be of relevant use for an attacker (i. e. its capabilities are limited) since the functions are designed in a specific way. The first possibility is specified by FMT_LIM.2 and the second one by FMT_LIM.1. Since these requirements are combined to support the policy, which is suitable to fulfil O.Abuse-Func, both security functional requirements together are suitable to meet the objective.
- 228 Other security functional requirements which prevent attackers from circumventing the functions implementing these two security functional requirements (for instance by manipulating the hardware) also support the objective. The relevant objectives are also listed in Table 7.
- 229 It was chosen to define FMT_LIM.1 and FMT_LIM.2 explicitly (not using Part 2 of the Common Criteria) for the following reason: Though taking components from the Common Criteria catalogue makes it easier to recognise functions, any selection from Part 2 of the Common Criteria would have made it harder for the reader to understand the special situation meant here. As a consequence, the statement of explicit security functional requirements was chosen to provide more clarity.
- 230 The justification related to the security objective “TOE Identification (O.Identification)” is as follows:
- 231 Obviously the operations for FAU_SAS.1 are chosen in a way that they require the TOE to provide the functionality needed for O.Identification. The Initialisation Data (or parts of them) are used for TOE identification. The technical capability of the TOE to store Initialisation Data and/or Pre-personalisation Data is provided according to FAU_SAS.1.
- 232 It was chosen to define FAU_SAS.1 explicitly (not using a given security functional requirement from Part 2 of the Common Criteria) for the following reason: The security functional requirement FAU_GEN.1 in Part 2 of the CC requires the TOE to generate the audit data and gives details on the content of the audit records (for instance data and time). The possibility to use the functions in order to store security relevant data which are generated outside of the TOE, is not covered by the family FAU_GEN or by other families in Part 2. Moreover, the TOE cannot add time information to the records, because it has no real time clock. Therefore, the new family FAU_SAS was defined for this situation.
- 233 The objective must be supported by organisational and other measures, which the TOE Manufacturer has to implement. These measures are a subset of those measures, which are examined during the evaluation of the assurance requirements of the classes AGD and ALC.
- 234 The justification related to the security objective “Random Numbers (O.RND)” is as follows:
- 235 FCS_RNG.1 requires the TOE to provide random numbers of good quality. The metrics associated to the DTRNG FRO M given by the SFRs FCS_RNG.1/RGS-IC and FCS_RNG/PTG.2.
- 236 Other security functional requirements, which prevent physical manipulation and malfunction of the TOE (see the corresponding objectives listed in the table), support this objective because they prevent attackers from manipulating or otherwise affecting the random number generator.
-

- 237 Random numbers are often used by the Security IC Embedded Software to generate cryptographic keys for internal use. Therefore, the TOE must prevent the unauthorised disclosure of random numbers. Other security functional requirements which prevent inherent leakage attacks, probing and forced leakage attacks ensure the confidentiality of the random numbers provided by the TOE.
- 238 Depending on the functionality of specific TOEs the Security IC Embedded Software will have to support the objective by providing runtime-tests of the random number generator. Together, these requirements allow the TOE to provide cryptographically good random numbers and to ensure that no information about the produced random numbers is available to an attacker.
- 239 It was chosen to define FCS_RNG.1 explicitly, because Part 2 of the Common Criteria does not contain generic security functional requirements for Random Number generation. (Note, that there are security functional requirements in Part 2 of the Common Criteria, which refer to random numbers. However, they define requirements only for the authentication context, which is only one of the possible applications of random numbers.)
- 240 The security objective "Capability and availability of the Loader (O.Cap_Avail_Loader) is directly covered by the SFR FMT_LIM.1/Loader and FMT_LIM.2/Loader.
- 241 The security objective Access control and authenticity for the Loader (O.Ctrl_Auth_Loader) is covered by the SFR as follows:
- 242 The SFR FDP_ACC.1/Loader defines the subjects, objects and operations of the Loader SFP enforced by the SFR FTP_ITC.1, FDP_UCT.1, FDP_UIT.1 and FDP_ACF.1/Loader.
- 243 The SFR FTP_ITC.1 requires the TSF to establish a trusted channel with assured identification of its end points and protection of the channel data from modification or disclosure.
- 244 The SFR FDP_UCT.1 requires the TSF to receive data protected from unauthorised disclosure.
- 245 The SFR FDP_UIT.1 requires the TSF to verify the integrity of the received user data.
- 246 The SFR FDP_ACF.1/Loader requires the TSF to implement access control for the Loader functionality.
- 247 The FCS_COP.1/TDES meets the security objective "Cryptographic service Triple-DES (O.TDES)".
- 248 The FCS_COP.1/AES meets the security objective "Cryptographic service AES (O.AES)".
- 249 The security functional requirement(s) "Cryptographic operation (FCS_COP.1/RSA,FCS_COP.1/ECDSA,ECDH)" exactly requires those functions to be implemented which are demanded by O.RSA or O.ECC. FCS_CKM.1 supports the generation of keys needed for this cryptographic operations(optional). Therefore, FCS_COP.1/RSA, FCS_COP.1/ECDSA, FCS_COP.1/ECDH, FCS_CKM.1/RSA and FCS_CKM.1/ ECDSA are suitable to meet the security objective.
- 250 The FCS_COP.1/SHA meet the security objective "Cryptographic service SHA (O.SHA)".
- 251 The security objective "Authentication to external entities (O.Authentication) is directly covered by the SFR FIA_API.1.
- 252 The justification related to the security objective "Area based Memory Access Control (O.Mem-Access)" is as follows:
- 253 The security functional requirement "Subset access control (FDP_ACC.1)" with the related Security Function Policy (SFP) "Memory Access Control Policy" exactly require the implementation of an area based
-

memory access control, which is a requirement from O.Mem-Access. Therefore, FDP_ACC.1 with its SFP is suitable to meet the security objective.

- 254 The security functional requirement “Static attribute initialisation (FMT_MSA.3)” requires that the TOE provides default values for the security attributes. Since the TOE is a hardware platform these default values are generated by the reset procedure. Therefore FMT_MSA.3 is suitable to meet the security objective O.Mem-Access.
- 255 The security functional requirement “Management of security attributes (FMT_MSA.1)” requires that the ability to change the security attributes is restricted to privileged subject(s). It ensures that the access control required by O.Mem-Access can be realised using the functions provided by the TOE. Therefore FMT_MSA.1 is suitable to meet the security objective O.Mem_Access.
- 256 Finally, the security functional requirement “Specification of Management Functions (FMT_SMF.1)” is used for the specification of the management functions to be provided by the TOE as required by O.MEM_ACCESS. Therefore, FMT_SMF.1 is suitable to meet the security objective O.Mem_Access.
- 257 The justification related to the security objective “Protection during Packaging, Finishing and Personalisation (OE.Process-Sec-IC)” is as follows:
- 258 The Composite Product Manufacturer has to use adequate measures to fulfil OE.Process-Sec-IC. Depending on the security needs of the application, the Security IC Embedded Software may have to support this for instance by using appropriate authentication mechanisms for personalisation functions.
- 259 The security objective Protection of the confidentiality of the TSF (O.Prot_TSF_Confidentiality) is covered by the SFR as follows:
- 260 The SFR FDP_ACC.1/Loader defines the subjects, objects and operations of the Loader SFP enforced by the FDP_ACF.1/Loader.
- 261 The SFR FDP_ACF.1/Loader requires the TSF to implement authentication mechanism for the Protection of the confidentiality of the TSF

6.3.2 Dependencies of Security Functional Requirements

- 262 Table 8 below lists the security functional requirements defined in this Security Target, their dependencies and whether they are satisfied by other security requirements defined in this Security Target. The text following the table discusses the remaining cases.

| Security Functional Requirement | Dependencies | Fulfilled by security requirements |
|---------------------------------|--------------|------------------------------------|
| FRU_FLT.2 | FPT_FLS.1 | Yes |
| FPT_FLS.1 | None | No dependency |
| FMT_LIM.1 | FMT_LIM.2 | Yes |
| FMT_LIM.2 | FMT_LIM.1 | Yes |
| FAU_SAS.1 | None | No dependency |
| FDP_SDC.1 | None | No dependency |
| FDP_SDI.2 | None | No dependency |

| Security Functional Requirement | Dependencies | Fulfilled by security requirements |
|---------------------------------|--|--|
| FPT_PHP.3 | None | No dependency |
| FDP_ITT.1 | FDP_ACC.1 or FDP_IFC.1 | Yes |
| FDP_IFC.1 | FDP_IFF.1 | See discussion below |
| FPT_ITT.1 | None | No dependency |
| FCS_RNG.1/PTG.2 | None | No dependency |
| FCS_RNG.1/RGS-IC | None | No dependency |
| FCS_COP.1 /TDES | FCS_CKM.4 | Yes (by environment, see discussion below) |
| | FDP_ITC.1 or FDP_ITC.2 (if not FCS_CKM.1) or FCS_CKM.1 | Yes (by environment, see discussion below) |
| FCS_COP.1 /AES | FCS_CKM.4 | Yes (by environment, see discussion below) |
| | FDP_ITC.1 or FDP_ITC.2 (if not FCS_CKM.1) or FCS_CKM.1 | Yes (by environment, see discussion below) |
| FCS_CKM.1 /RSA (optional) | FCS_COP.1 or FCS_CKM.2 | Yes |
| | FCS_CKM.4 | Yes (by environment, see discussion below) |
| FCS_COP.1/RSA (optional) | FDP_ITC.1 or FDP_ITC.2 or FCS_CKM.1 | Yes |
| | FCS_CKM.4 | Yes (by environment, see discussion below) |
| FCS_COP.1/ECDSA (optional) | FDP_ITC.1 or FDP_ITC.2 or FCS_CKM.1 | Yes |
| | FCS_CKM.4 | Yes (by environment, see discussion below) |
| FCS_COP.1/ECDH (optional) | FDP_ITC.1 or FDP_ITC.2, or FCS_CKM.1 | Yes |
| | FCS_CKM.4 | Yes (by environment, see discussion below) |
| FCS_CKM.1 /ECDSA (optional) | FCS_COP.1 or FCS_CKM.2 | Yes |
| | FCS_CKM.4 | Yes (by environment, see discussion below) |
| FCS_COP.1/SHA (optional) | FDP_ITC.1 or FDP_ITC.2 or FCS_CKM.1,FCS_CKM.4 | See discussion below |
| FDP_ACC.1 | FDP_ACF.1 | Yes |
| FDP_ACF.1 | FDP_ACC.1 FMT_MSA.3 | Yes Yes |

| Security Functional Requirement | Dependencies | Fulfilled by security requirements |
|---------------------------------|---|------------------------------------|
| FMT_MSA.3 | FMT_MSA.1 FMT_SMR.1 | Yes See discussion below |
| FMT_MSA.1 | FDP_ACC.1 or FDP_IFC.1 FMT_SMR.1 FMT_SMF.1 | Yes See discussion below Yes |
| FMT_SMF.1 | None | No dependency |
| FMT_LIM.1/Loader | FMT_LIM.2 | Yes |
| FMT_LIM.2/Loader | FMT_LIM.1 | Yes |
| FTP_ITC.1 | None | No dependency |
| FDP_UCT.1 | FTP_ITC.1 or FTP_TRP.1, FDP_ACC.1 or FDP_IFC.1 | Yes |
| FDP_UIT.1 | FTP_ITC.1 or FTP_TRP.1, FDP_ACC.1 or FDP_IFC.1 | Yes |
| FDP_ACC.1/ Loader | FDP_ACF.1 | Yes |
| FDP_ACF.1/ Loader | FMT_MSA.3 | See discussion below |
| | FDP_ACC.1 | Yes |
| FIA_API.1 | None | No dependency |

Table 8 Dependencies of the Security Functional Requirements

- 263 Part 2 of the Common Criteria defines the dependency of FDP_IFC.1 (information flow control policy statement) on FDP_IFF.1 (Simple security attributes). The specification of FDP_IFF.1 would not capture the nature of the security functional requirement nor add any detail. As stated in the Data Processing Policy referred to in FDP_IFC.1 there are no attributes necessary. The security functional requirement for the TOE is sufficiently described using FDP_ITT.1 and its Data Processing Policy (FDP_IFC.1). Therefore the dependency is considered satisfied.
- 264 In particular the security functional requirements providing resistance of the hardware against manipulations (e. g. FPT_PHP.3) support all other more specific security functional requirements (e. g. FCS_RNG.1) because they prevent an attacker from disabling or circumventing the latter. Together with the discussion of the dependencies above this shows that the security functional requirements build a mutually supportive whole.
- 265 The functional requirements FCS_CKM.1 and FCS_CKM.4 which are dependent to FCS_COP.1/DES and FCS_COP.1/AES are not included in this Security Target since the TOE only provides an engine for encryption and decryption. But the Security IC Embedded Software may fulfill these requirements related to the needs of the implemented application. The dependent requirements of FCS_COP.1/DES and FCS_COP.1/AES concerning these functions shall be fulfilled by the environment (Security IC Embedded Software).
- 266 The TOE provides the cryptographic key generation for RSA and ECDSA by the TOE (FCS_CKM.1/RSA, FCS_CKM.1/ECDSA), but it is up to the Smart Card Embedded Software's security policy to adopt the cryptographic key generation by the TOE or use the cryptographic key generation by the Smart Card Embedded Software. The dependent requirements of FCS_COP.1/RSA and FCS_COP.1/ECDSA shall be

fulfilled by the environment (Security IC Embedded Software).

- 267 The functional requirement FCS_CKM.1 which is dependent to FCS_COP.1/ECDH is not included in this Security Target. But the Security IC Embedded Software may fulfill this requirement related to the needs of the implemented application. The dependent requirements of FCS_COP.1/ECDH concerning this function shall be fulfilled by the environment (Security IC Embedded Software).
- 268 The functional requirement FCS_CKM.4 which is dependent to FCS_COP.1/RSA, FCS_COP.1/ECDH and FCS_COP.1/ECDSA are not included in this Security Target. But the Security IC Embedded Software may fulfill this requirement related to the needs of the implemented application. The dependent requirements of FCS_COP.1/RSA, FCS_COP.1/ECDH and FCS_COP.1/ECDSA concerning this function shall be fulfilled by the environment (Security IC Embedded Software).
- 269 Since SHA is a keyless algorithm, there is no need for key import as required by dependency to FDP_ITC.1, FDP_ITC.2 or key generation as required by dependency to FCS_CKM.1 or destruction as required by dependency to FCS_CKM.4. So the dependencies to FDP_ITC.1, FDP_ITC.2, FCS_CKM.1 and FMT_CKM.4 are not required.
- 270 The dependency FMT_SMR.1 introduced by the two components FMT_MSA.1 and FMT_MSA.3 is considered to be satisfied because the access control specified for the intended TOE is not role-based but enforced for each subject. Therefore, there is no need to identify roles in form of a security functional requirement FMT_SMR.1.
- 271 The dependency FMT_MSA.3 of FDP_ACF.1/Loader is not be necessary. The security attributes of ROM and Flash used to enforce the Loader SFP are fixed by the IC manufacturer. The access attribute of ROM and Flash memory have DEFAULT value.

6.3.3 Rationale for the Assurance Requirements

- 272 The assurance level EAL6 and the augmentation with the requirement ASE_TSS.2 were chosen to demonstrate that the TOE fulfills the high-level Common Criteria requirements. An assurance level of EAL6 is required for this type of TOE since it is intended to defend against sophisticated attacks. This evaluation assurance level was selected since it is designed to permit a developer to gain maximum assurance from positive security engineering based on good commercial practices. In order to provide a meaningful level of assurance that the TOE provides an adequate level of defense against such attacks, the evaluators should have access to the low level design and all the source code.
- 273 In addition, the TOE security policy is formally described and its security objective i.e. the complete memory access control is formally proved. The ASE_TSS.2 was chosen to demonstrate further assurance extensions provided by the TOE.

6.3.3.1 ADV_SPM.1 Formal TOE Security Policy Model

- 274 The formally modeled security policy consists of the complete TSF access control, in particular:
- The access control to the security registers, the Flash, ROM regions and Booting memory area are correctly enforced.
 - The access control with respect to the MPU memory areas is correctly enforced, in particular:
 - A data is accessible if and only if its address is included in one of the Data Memory areas and this
-

- area has the access right (i.e. Read-only or Writing), overlapping rule applied;
- A data is writable if and only if
 - its address is included in one of the Data Memory areas and this area has the Writing right, and
 - its address is not included in any Data Memory area with higher priority that has the Read-only or No-Access right;
- A code element is executable if and only if its address is included in one of the Program Memory areas and this area has the Execute right, overlapping rule applied;
- Any other access is a violation and is detected by the TSF;
- The consistency of the memory areas is correctly enforced i.e.
 - All memory areas and access rights are correctly initialized at the IC reset
 - Each fixed data area is completely contained in the physical memory space of its memory type:
 - DMA_RAM_DATA, CRYPTO_RAM_DATA, CRYPTO_RAM_CODE must be included in RAM space;
 - SECURITY_AREA, OTP_AREA and PASSWORD_AREA must be included in NVM space.

6.3.3.2 ASE_TSS.2 TOE Summary specification with architectural design summary

- 275 The augmentation ASE_TSS.2 is required in order to provide the potential users (e.g. the embedded software developers) with a succinct but comprehensive explanation on the TOE security functions that protect it against interference, logical tampering and bypass. This description is also necessary to establish the component ASE_TSS.2 for any composed TOE.
- 276 This assurance component is a higher hierarchical component to EAL6. ASE_TSS.2 has two dependencies (ASE_INT.1 and ASE_REQ.1) that both are satisfied by this TOE.

6.3.4 Security Requirements are Internally Consistent

- 277 The discussion of security functional requirements and assurance components in the preceding sections has shown that mutual support and consistency are given for both groups of requirements. The arguments given for the fact that the assurance components are adequate for the functionality of the TOE also shows that the security functional requirements and assurance requirements support each other and that there are no inconsistencies between these groups.
- 278 The security functional requirements FDP_SDC.1 and FDP_SDI.2 address the protection of user data in the specified memory areas against compromise and manipulation. The security functional requirement FPT_PHP.3 makes it harder to manipulate data. This protects the primary assets identified in Section 3.1 and other security features or functionality which use these data.
- 279 Though a manipulation of the TOE (refer to FPT_PHP.3) is not of great value for an attacker in itself, it can be an important step in order to threaten the primary assets. Therefore, the security functional requirement FPT_PHP.3 is not only required to meet the security objective O.Phys-Manipulation. Instead it protects other security features or functions of both the TOE and the Security IC Embedded Software from being bypassed, deactivated or changed. In particular this may pertain to the security features or functions being

specified using FDP_ITT.1, FPT_ITT.1, FPT_FLS.1, FMT_LIM.2, FCS_RNG.1, and those implemented in the Security IC Embedded Software.

- 280 A malfunction of TSF (refer to FRU_FLT.2 and FPT_FLS.1) can be an important step in order to threaten the primary assets. Therefore, the security functional requirements FRU_FLT.2 and FPT_FLS.1 are not only required to meet the security objective O.Malfunction. Instead they protect other security features or functions of both the TOE and the Security IC Embedded Software from being bypassed, deactivated or changed. In particular this pertains to the security features or functions being specified using FDP_ITT.1, FPT_ITT.1, FMT_LIM.1, FMT_LIM.2, FCS_RNG.1, and those implemented in the Security IC Embedded Software.
- 281 In a forced leakage attack the methods described in “Malfunction due to Environmental Stress” (refer to T.Malfunction) and/or “Physical Manipulation” (refer to T.Phys-Manipulation) are used to cause leakage from signals which normally do not contain significant information about secrets. Therefore, in order to avert the disclosure of primary assets it is important that the security functional requirements averting leakage (FDP_ITT.1, FPT_ITT.1) and those against malfunction (FRU_FLT.2 and FPT_FLS.1) and physical manipulation (FPT_PHP.3) are effective and bind well. The security features and functions against malfunction ensure correct operation of other security functions (refer to above) and help to avert forced leakage themselves in other attack scenarios. The security features and functions against physical manipulation make it harder to manipulate the other security functions (refer to above).
- 282 Physical probing (refer to FPT_PHP.3) shall directly avert the disclosure of primary assets. In addition, physical probing can be an important step in other attack scenarios if the corresponding security features or functions use secret data. For instance the security functional requirement FMT_LIM.2 may use passwords. Therefore, the security functional requirement FPT_PHP.3 (against probing) help to protect other security features or functions including those being implemented in the Security IC Embedded Software. Details depend on the implementation.
- 283 Leakage (refer to FDP_ITT.1, FPT_ITT.1) shall directly avert the disclosure of primary assets. In addition, inherent leakage and forced leakage (refer to above) can be an important step in other attack scenarios if the corresponding security features or functions use secret data. For instance the security functional requirement FMT_LIM.2 may use passwords. Therefore, the security functional requirements FDP_ITT.1 and FPT_ITT.1 help to protect other security features or functions implemented in the Security IC Embedded Software (FDP_ITT.1) or provided by the TOE (FPT_ITT.1). Details depend on the implementation.
- 284 The user data of the Composite TOE are treated as required to meet the requirements defined for the specific application context (refer to Treatment of user data of the Composite TOE (A.Resp-App)). However, the TOE may implement additional functions. This can be a risk if their interface cannot completely be controlled by the Security IC Embedded Software. Therefore, the security functional requirements FMT_LIM.1 and FMT_LIM.2 are very important. They ensure that appropriate control is applied to the interface of these functions (limited availability) and that these functions, if being usable, provide limited capabilities only.
- 285 The combination of the security functional requirements FMT_LIM.1 and FMT_LIM.2 ensures that (especially after TOE Delivery) these additional functions cannot be abused by an attacker to (i) disclose or manipulate user data of the Composite TOE, (ii) to manipulate (explore, bypass, deactivate or change) security features or services of the TOE or of the Security IC Embedded Software or (iii) to enable other attacks on the assets. Hereby the binding between these two security functional requirements is very important:
- 286 The security functional requirement Limited Capabilities (FMT_LIM.1) must close gaps which could be left
-

by the control being applied to the function's interface (Limited Availability (FMT_LIM.2)). Note that the security feature or services which limits the availability can be bypassed, deactivated or changed by physical manipulation or a malfunction caused by an attacker. Therefore, if Limited Availability (FMT_LIM.2) is vulnerable, it is important to limit the capabilities of the functions in order to limit the possible benefit for an attacker.

- 287 The security functional requirement Limited Availability (FMT_LIM.2) must close gaps which could result from the fact that the function's kernel in principle would allow to perform attacks. The TOE must limit the availability of functions which potentially provide the capability to disclose or manipulate user data of the Composite TOE, to manipulate security features or services of the TOE or of the Security IC Embedded Software or to enable other attacks on the assets. Therefore, if an attacker could benefit from using such functions, it is important to limit their availability so that an attacker is not able to use them.
- 288 No perfect solution to limit the capabilities (FMT_LIM.1) is required if the limited availability (FMT_LIM.2) alone can prevent the abuse of functions. No perfect solution to limit the availability (FMT_LIM.2) is required if the limited capabilities (FMT_LIM.1) alone can prevent the abuse of functions. Therefore, it is correct that both requirements are defined in a way that they together provide sufficient security.
- 289 It is important to avert malfunctions of TSF and of security functions implemented in the Security IC Embedded Software (refer to above). There are two security functional requirements which ensure that malfunctions cannot be caused by exposing the TOE to environmental stress. First it must be ensured that the TOE operates correctly within some limits (Limited fault tolerance (FRU_FLT.2)). Second the TOE must prevent its operation outside these limits (Failure with preservation of secure state (FPT_FLS.1)). Both security functional requirements together prevent malfunctions. The two functional requirements must define the "limits". Otherwise there could be some range of operating conditions which is not covered so that malfunctions may occur. Consequently, the security functional requirements Limited fault tolerance (FRU_FLT.2) and Failure with preservation of secure state (FPT_FLS.1) are defined in a way that they together provide sufficient security.
- 290 The security functional requirements required to meet the security objectives O.Leak-Inherent, O.Phys-Probing, O.Malfunction, O.Phys-Manipulation and O.Leak-Forced protect the cryptographic algorithms (FCS_COP.1) and the cryptographic key generations (FCS_CKM.1). Therefore these security functional requirements support the secure implementation and operation of FCS_COP.1 and FCS_CKM.1.
- 291 Parts of the Smartcard IC Embedded Software may cause security violations by accidentally or deliberately accessing restricted data (which may include code). In order to avert the memory access violation it is important to the security functional requirement defining the scope where the Memory Access Policy is applied (FDP_ACC.1) and the security functional requirement defining the Memory Access Policy (FDP_ACF.1), and the security functional requirement ensuring the default value of security attribute (FMT_MSA.3) and the security functional requirement managing security attribute (FMT_MSA.1) and the security functional requirement performing security management function (FMT_SMF.1) are effective and bind well.
- 292 Two refinements from the PP [5] have to be discussed here in the ST as the assurance level is increased. The refinement for ALC_CMS from the PP [5] can even be applied at the assurance level EAL 6 augmented with ALC_CMS.5. The assurance component ALC_CMS.4 is augmented to ALC_CMS.5 with aspects regarding the configuration control system for the TOE. The refinement is not touched. The refinement for ADV_FSP from the PP [5] can even be applied at the assurance level EAL 6 augmented with ADV_FSP.5. The assurance component ADV_FSP.4 is extended to ADV_FSP.5 with aspects regarding the description level. The level is increased from informal to semi-formal with informal description. The refinement is not touched by this measure
-

7 TOE SUMMARY SPECIFICATION

293 This chapter 7 TOE Summary Specification contains the following sections:

7.1 List of Security Functional Requirements

7.1 List of Security Functional Requirements

SFR1: FPT_FLS.1: Failure with preservation of secure state

294 The detection thresholds of TOE's detectors are inside the operating range of the TOE. Therefore abnormal events/failures are detected before the secure state is compromised. This allows to take User's defined appropriate actions by software or to immediately RESET the TOE.

295 The secure state is maintained by TOE's detectors. The TOE's detectors are monitoring the failure occurs. If the failures are happen, the TOE goes into RESET state. This satisfies the FPT_FLS.1 "Failure with preservation of secure state."

TOE's Detectors

296 These functions records in register the events notified by the detectors (refer to list below). The software configures the reaction in case of detection:

- The TOE is immediately reset when an event is detected.
- Or, a special function register bit is set.

TOE's detectors are implemented by the hardware. The detection cannot be affected or bypassed by Smartcard Embedded Software. The reaction to the detection can be configured by the software. The influence on security and the way how to configure it is described in details in the S3D384C Family User's Manual. Therefore, FPT_FLS.1 is implemented by TOE.

297 Security domains are maintained since accesses to the access-prohibited area are trapped by this access control function.

SFR2: FRU_FLT.2: Limited fault tolerance

298 All operating signals are filtered/regulated in order to prevent malfunction.

TOE's Filters

299 These filters are used for preventing noise, glitches and extremely high frequency in the external reset or clock pad from causing undefined or unpredictable behavior of the chip.

Integrity Checkers

300 These Integrity Checkers are used for preventing noise and laser from causing undefined or unpredictable behavior of the chip.

301 TOE's filters and integrity checkers are implemented by the hardware. The filtering cannot be affected or bypassed by Smartcard Embedded Software. The reaction to the detection can be configured by the software. The influence on security and the way how to configure it is described in details in the S3D384C

families User's Manual. Therefore, FRU_FLT.2 is implemented by TOE. Refer to the table 9 for the filters specification.

SFR3: FPT_PHP.3: Resistance to physical attacks

302 This requirement is achieved by security feature as the shield must be removed and bypassed in order to perform physical intrusive attacks. The TOE makes appropriate secure reaction to stops operation if a physical manipulation or physical probing attack is detected. And also scrambling and encryption mechanisms make reverse engineering of the TOE layout unpractical and protect from probing attack and signal identification of the TOE layout unpractical. So these functionalities meet the security functional requirement of FPT_PHP.3: Resistance to physical attack.

SFR4: FDP_ACC.1: Subset access control

303 This requirement is achieved by security register access control, invalid address access and access right for the code executed in FLASH.

- 1) Security registers access control: This security function manages access to the security control registers through access control security attributes.
- 2) Invalid address access: This function detects invalid address access occurrence allowing to take dedicated and appropriate actions.
- 3) Access rights for the code executed in FLASH.
- 4) Access control for Operating state: This security function selects booting memory area (reset path). User can select ROM-BOOT.
- 5) Flash protection about Write operation: This function provides protection about flash write operation.

SFR5: FDP_ACF.1: Security attributes based access control.

304 This is covered by the Privilege and User modes of the TOE.

SFR6: FMT_MSA.3: Static attribute initialization.

305 All Special Function Registers including MPU have DEFAULT values after Power on Reset.

The access attribute of ROM and Flash memory have DEFAULT values.

SFR7: FMT_MSA.1: Management of security attributes.

306 This is achieved with the following feature.

The Memory Protection Unit (MPU) enables user to partition memory and set individual protection attributes for each partition. This allows the operating system to control the memory regions accessible by a User mode application process.

OPRSEL controls ROM and NVM (flash) memory security attributes. It controls the operating mode of the chip.

Management of OPRSEL and MPU configuration is only possible in privilege mode

SFR8: FMT_SMF.1: Specification of management functions.

307 This is achieved via access to Special Function Registers of Memory Protection Unit(MPU). MPU provides Special Function Registers which defines the base address and the limit address for a partition. The Registers exist for Flash, and RAM. Additional Registers exist for defining the protection attribute for each partition.

SFR9: FAU_SAS.1: Audit Storage

308 This is fulfilled by the traceability/identification data written once and for all during the TEST mode of the manufacturing process.

- 1) Non-reversibility of TEST mode and NORMAL mode: This function disables the TEST mode and enables the NORMAL mode of the TOE. This function ensures the non-reversibility of the NORMAL mode. This function is used once during the manufacturing process.
- 2) TEST mode communication protocol and data commands: This function is the proprietary protocol used to operate the chip in TEST mode. This function enforces the identification and authentication of the TEST administrator during the test phase of the manufacturing process.
- 3) Functional Tests: During the manufacturing process, the operation of the TOE and the embedded software checksum are verified. This security function ensures the correct operation of the TOE security functions and the integrity of the embedded software.
- 4) Identification: During the TEST mode of manufacturing process, traceability data are written in the non-volatile memory of the TOE. Once the TOE is switched from TEST to NORMAL mode, those traceability data are READ ONLY and cannot be modified anymore. In particular, user can identify the silicon chip version and the version of the device Dedicated SW parts (Test ROM code, Bootloader). The DTRNG FRO M library and RSA/ECC/SHA library version are identified by the version function in the library.

SFR10: FMT_LIM.1: Limited capabilities

309 TEST mode can be accessed only by the TEST administrator by supplying an authentication password through a proprietary protocol. Once the TOE is changed to NORMAL mode, TEST mode functions are no more available for NORMAL mode.

SFR11: FMT_LIM.2: Limited availabilities

310 TEST mode can be accessed only by the TEST administrator by supplying an authentication password through a proprietary protocol. Once the TOE is changed to NORMAL mode, TEST mode commands are no more available for NORMAL mode. Functional test during manufacturing process is only available for TEST mode only.

SFR12: FDP_IFC.1: Subset information flow control

311 Memory Encryption: This is achieved by the function protects the memory contents of the TOE from data analysis on the stored data as well as on internally transmitted data.

Shield: This requirement is achieved by security feature as the Active shield must be removed and bypassed in order to perform physical intrusive attacks.

Life time detector: Life time detector detects if detector signals are modified or not.

SFR13: FDP_ITT.1: Basic internal transfer protection

312 This requirement is achieved by the combination of the TOE security features TOE features 1) to 5) as it is impractical to get access to internal signals and interpret them.

- 1) Static Address/Data scrambling for bus and memory: This function protects memory and address/data bus from probing attacks.
- 2) Dynamic Data encryption for bus: This function protects data bus from probing attacks.
- 3) Memory encryption: This security function protects the memory contents of the TOE from data analysis on the stored data as well as on internally transmitted data.
- 4) Synthesizable processor core: The Central Processing Unit (CPU) of the TOE is synthesizable with glue logic, which makes reverse engineering and signal identification more difficult.
- 5) De-synchronization and signal-to-noise ratio reduction mechanisms: The TOE operations can be made asynchronous. They make a full range of intrusive (e.g. probing attacks) and non intrusive attacks (e.g. side-channel attacks) more complex and difficult.

SFR14: FPT_ITT.1: Basic internal TSF data transfer protection

313 This requirement is achieved by the combination of the TOE security features TOE features 1) to 5) as it is impractical to get access to internal signals and interpret them.

- 1) Static Address/Data scrambling for bus and memory: This function protects memory and address/data bus from probing attacks.
- 2) Dynamic Data encryption for bus: This function protects data bus from probing attacks.
- 3) Memory encryption: This security function protects the memory contents of the TOE from data analysis on the stored data as well as on internally transmitted data.
- 4) Synthesizable processor core: The Central Processing Unit (CPU) of the TOE is synthesizable with glue logic, which makes reverse engineering and signal identification more difficult.
- 5) De-synchronization and signal-to-noise ratio reduction mechanisms: The TOE operations can be made asynchronous. They make a full range of intrusive (e.g. probing attacks) and non intrusive attacks (e.g. side-channel attacks) more complex and difficult.

SFR15: FCS_RNG.1: Random number generation

FCS_RNG.1/PTG.2

- 314 This requirement is ensured by the design of the random number generation algorithm that makes use of Digital True Random Number Generator (DTRNG FRO M) and the associated DTRNG FRO M library conforming to *BSI-AIS31 Class PTG.2* requirements (German scheme).

FCS_RNG.1/RGS-IC

- 315 This requirement is ensured by the design of the random number generation algorithm that makes use of Digital True Random Number Generator (DTRNG FRO M) and the associated DTRNG FRO M library conforming to some of *ANSSI RGS* requirements (French scheme).

SFR16: FCS_COP.1: Cryptographic operation

- 316 This requirement is covered by the TOE.

Triple Data Encryption Standard Engine

- 317 This function is used for encrypting and decrypting data using the Triple DES symmetric algorithm with 112bit or 168bit key size. (FCS_COP.1/TDES)

AES (Advanced Encryption Standard)

- 318 This function supports the AES operation with 128 bit, 192bit and 256bit key size. (FCS_COP.1/AES)

TORNADO-T RSA Cryptographic Library as part of AT1 Secure RSA/ECC/SHA library (optional)

This function assists in the acceleration of modulo exponentiations required in the RSA encryption/decryption algorithm. (FCS_COP.1/RSA)

TORNADO-T is a high speed modular multiplication coprocessor for the support of the RSA public key cryptosystem. The TORNADO-T RSA Library is the software built on the TORNADO-T coprocessor that provides high level interface for RSA-based algorithms.

The functions of the library included in the evaluation are:

- TND_RSA_SigSTD_Secure (RSA signature generation with the standard method)
- TND_RSA_SigCRT_Secure (RSA signature generation with CRT method)
- TND_RSA_Verify (RSA signature verification)
This function performs the RSA signature verification. Since this function uses only the public information, it does not implement any dedicated countermeasures against the side-channel attacks.
- RSA_R2modM_precompute_sec (R² value precomputation for the standard RSA)
This function calculates the R² value for the Montgomery constant R, which will then be used for the subsequent standard RSA operations.
- RSA_R2modPandQ_precompute_sec (R² value precomputation for the CRT RSA)
This function calculates the R² value for the Montgomery constant R, which will then be used for the subsequent CRT RSA operations.

The TND_RSA_SigSTD_Secure and TND_RSA_SigCRT_Secure have some countermeasure against the timing attack, SPA, DPA and the fault attack.

The RSA_R2modM_precompute_sec and RSA_R2modPandQ_precompute_sec functions implement some countermeasures against the fault attack.

TORNADO-T ECC Cryptographic Library as part of Secure RSA/ECC/SHA library (optional)

This function assists in the acceleration of required for the ECC cryptographic operations including the ECDSA signature generation/verification and the ECDH secret key derivation. (FCS_COP.1/ECDSA and FCS_COP.1/ECDH)

TORNADO-T RSA/ECC/SHA library provides a set of functions to implement elliptic curve cryptographic algorithms. In particular, it provides some functions to implement the ECDSA signature generation/verification and the ECDH secret key derivation.

The functions of the library included in the evaluation are:

- ECDSA_sign_digest
- ECDSA_verify_digest
- ECDH_generate

This function generates a shared secret value for the ECDH key exchange protocol.

The functions ECDSA_sign_digest and ECDH_generate have some countermeasure against the timing attack, SPA and the fault attack. The ECDSA_verify_digests function has some countermeasures against the fault attack.

The TORNADO-T Secure RSA/ECC/SHA library provides the functions to calculate hash (digest) values using the SHA1, SHA224, SHA256, SHA384 and SHA 512 algorithm as specified in [FIPS PUB 180-3], but only the functions related to SHA224, SHA256, SHA384 and SHA512 listed below are in the scope of this evaluation (FCS_COP.1/SHA):

- SHA224_init, SHA224_update, SHA224_final,
- SHA256_init, SHA256_update, SHA256_final.
- SHA384_init, SHA384_update, SHA384_final.
- SHA512_init, SHA512_update, SHA512_final.

SFR17: FCS_CKM.1: Cryptographic key generation

2 This requirement is covered by the TOE for the RSA/ECC key generation. (optional)

RSA_KeyGen_Secure - FCS_CKM.1/RSA.

- This function generates an RSA public/private key pair.

3 ECDSA_keygen - FCS_CKM.1/ECDSA.

- This function generates an ephemeral or static public/private key for the ECDSA signature generation.

SFR18: Limited capabilities - Loader(FMT_LIM.1/Loader)

This requirement is achieved by changing the Operating Mode Selection from ROM Booting mode to FLASH Booting mode and then locking the Operating Mode. If the chip is locked in FLASH Booting mode, the Bootloader cannot be deployed any more. It is then not possible to use the FLASH read and write commands of the Bootloader to read, download or modify any data or code in FLASH.

SFR19: Limited availability - Loader (FMT_LIM.2/Loader)

This requirement is achieved by changing the Operating Mode Selection from ROM Booting mode to FLASH Booting mode and then locking the Operating Mode. The Bootloader is only supported in ROM Booting mode. In FLASH Booting mode, the Bootloader does not operate.

SFR20: Inter-TSF trusted channel (FTP_ITC.1)

This requirement is achieved by processing the Authentication sequence. This channel is only distinct from other communication channels and provides assured identification for its end points and protection of the channel data from modification or disclose.

SFR21: Basic data exchange confidentiality (FDP_UCT.1)

This requirement is achieved by secure writing. User data which is loaded to flash memory is encrypted data.

SFR22: Data exchange integrity (FDP_UIT.1)

This requirement is achieved by appropriate code integrity mechanism.

SFR23: Subset access control - Loader (FDP_ACC.1/Loader)

This requirement is achieved by following functions.
FLASH memory attribute as Read only.

SFR24: Security attribute based access control - Loader (FDP_ACF.1/Loader)

This is covered by the ROM Booting(ROM Reset) and Flash Booting(Flash Reset) mode of the TOE. TOE can be set to ROM Booting(ROM Reset) and FLASH Booting(FLASH Reset) mode domains exclusively. All Bootloader APDU commands are accessible only in Rom Booting mode. The Flash Booting mode can not access all Bootloader APDU commands.

SFR25: Stored data confidentiality (FDP_SDC.1)

This requirement is achieved by the combination of the TOE security features TOE features 1) to 4) as it is impractical to get access to internal signals and interpret them.

- 1) Static Address/Data scrambling for bus and memory: This function protects memory and address/data bus from probing attacks.
- 2) Data encryption for bus: This function protects data bus from probing attacks.
- 3) Memory encryption: This security function protects the memory contents of the TOE from data analysis on the stored data as well as on internally transmitted data.
- 4) Invalid address access: This function detects invalid address access occurrence.
- 5) Shield: This requirement is achieved by security feature as the shield must be removed and bypassed in order to perform physical intrusive attacks.
- 6) Life cycle detector: Life cycle detector detects modifications.
- 7) Filters.
- 8) Non-reversibility of TEST and NORMAL modes: This function disables the TEST mode and enables the NORMAL mode of the TOE. This function ensures the non-reversibility of the NORMAL mode. This function is used once during the manufacturing process.
- 9) Control of Booting mode: This requirement is achieved by the changing the Operating Mode Selection.

SFR26: Stored data integrity monitoring and action (FDP_SDI.2)

This requirement is achieved by following functions.

Flash/RAM: Error manages features.

SFR27: Authentication Proof of Identity (FIA_API.1)

This requirement is achieved by processing the Authentication sequence.

SFR28: Reserved

7.2 Architectural Design Summary

- 319 The TOE claims the assurance requirement ASE_TSS.2, the security architectural information on a very high level is included in the TSS to inform the embedded software developers on how the TOE protects itself against interference, logical tampering and bypass.
- 320 Interference
- 321 Interference consists in interfering in the TSF in order to get access to assets.
- 322 Logical tampering
- 323 Logical tampering consists in get access to the assets by a logical means (in contrast with physical tampering). For this TOE, logical tampering may be used on
- the access control
 - the information flow control
- 324 The access control is enforced by the following security functions: “Security registers access control”, “Invalid address access”, “Access rights for the code executed in FLASH”, “Access control for Operating state”, “Flash protection about Write operation”.
- 325 The information flow control is enforced by the following security function “Memory Encryption”.
- 326 Bypass
- 327 Non-bypassability is a property that the security functionality of the TSF is always invoked. For this TOE, bypassing a security function may be caused by
- 328 A physical perturbation on the IC: protection against this bypass if ensured by the security functions “Static Address/Data scrambling for bus and memory”, “Synthesizable processor core”, “Detectors”, “Filters”
- 329 Switching back from Normal mode to Test mode in order to get more privilege: protection against this bypass if ensured by the security functions “Non-reversibility of TEST mode and NORMAL mode”
- 330 Masking the security errors: protection against this bypass if ensured by the security function “Security registers access control”

8 Annex

8.1 Glossary

Application Data

All data managed by the Security IC Embedded Software in the application context. Application data comprise all data in the final Security IC.

Composite Product Integrator

Role installing or finalising the IC Embedded Software and the applications on platform transforming the TOE into the unpersonalised Composite Product after TOE delivery. The TOE Manufacturer may implement IC Embedded Software delivered by the Security IC Embedded Software Developer before TOE delivery (e.g. if the IC Embedded Software is implemented in ROM or is stored in the non-volatile memory as service provided by the IC Manufacturer or IC Packaging Manufacturer)

Composite Product Manufacturer

The Composite Product Manufacturer has the following roles (i) the Security IC Embedded Software Developer (Phase 1), (ii) the Composite Product Integrator (Phase 5) and (iii) the Personaliser (Phase 6). If the TOE is delivered after Phase 3 in form of wafers or sawn wafers (dice) he has the role of the IC Packaging Manufacturer (Phase 4) in addition.

End-consumer

User of the Composite Product in Phase 7.

IC Dedicated Software

IC proprietary software embedded in a Security IC (also known as IC firmware) and developed by the IC Developer. Such software is required for testing purpose (IC Dedicated Test Software) but may provide additional services to facilitate usage of the hardware and/or to provide additional services (IC Dedicated Support Software).

IC Dedicated Test Software

That part of the IC Dedicated Software (refer to above) which is used to test the TOE before TOE Delivery but which does not provide any functionality thereafter.

IC Dedicated Support Software

That part of the IC Dedicated Software (refer to above) which provides functions after TOE Delivery. The usage of parts of the IC Dedicated Software might be restricted to certain phases.

Initialisation Data

Initialisation Data defined by the TOE Manufacturer to identify the TOE and to keep track of the Security IC's production and further life-cycle phases are considered as belonging to the TSF data. These data are for instance

used for traceability and for TOE identification (identification data).

Integrated Circuit (IC)

Electronic component(s) designed to perform processing and/or memory functions.

Pre-personalisation Data

Any data supplied by the Card Manufacturer that is injected into the non-volatile memory by the Integrated Circuits manufacturer (Phase 3). These data are for instance used for traceability and/or to secure shipment between phases.

Security IC

Composition of the TOE, the Security IC Embedded Software, User Data and the package (the Security IC carrier).

Security IC Embedded Software

Software embedded in a Security IC and normally not being developed by the IC Designer. The Security IC Embedded Software is designed in Phase 1 and embedded into the Security IC in Phase 3 or in later phases of the Security IC product life-cycle. Some part of that software may actually implement a Security IC application others may provide standard services. Nevertheless, this distinction doesn't matter here so that the Security IC Embedded Software can be considered as being application dependent whereas the IC Dedicated Software is definitely not.

Security IC Product

Composite product which includes the Security Integrated Circuit (i.e. the TOE) and the Embedded Software and is evaluated as composite target of evaluation in the sense of the Supporting Document

TOE Delivery

The period when the TOE is delivered which is either (i) after Phase 3 (or before Phase 4) if the TOE is delivered in form of wafers or sawn wafers (dice) or (ii) after Phase 4 (or before Phase 5) if the TOE is delivered in form of packaged products.

TOE Manufacturer

The TOE Manufacturer must ensure that all requirements for the TOE and its development and production environment are fulfilled. The TOE Manufacturer has the following roles: (i) IC Developer (Phase 2) and (ii) IC Manufacturer (Phase 3). If the TOE is delivered after Phase 4 in form of packaged products, he has the role of the (iii) IC Packaging Manufacturer (Phase 4) in addition.

TSF data

Data created by and for the TOE, that might affect the operation of the TOE. This includes information about the TOE's configuration, if any is coded in non-volatile non-programmable memories (ROM), in specific circuitry, in non-volatile programmable memories (for instance E2PROM) or a combination thereof.

User data

All data managed by the Smartcard Embedded Software in the application context. User data comprise all data in the final Smartcard IC except the TSF data.

8.2 Abbreviations

CC

Common Criteria

EAL

Evaluation Assurance Level

IT

Information Technology

PP

Protection Profile

ST

Security Target

TOE

Target of Evaluation

TSC

TSF Scope of Control

TSF

TOE Security Functionality

TSFI

TSF Interface

TSP

TOE Security Policy

8.3 References

- [1] Common Criteria, Part 1: Common Criteria for Information Technology Security Evaluation, Part 1: Introduction and General Model, Version 3.1, Revision 5, April 2017, CCMB-2017-04-001
- [2] Common Criteria, Part 2: Common Criteria for Information Technology Security Evaluation, Part 2: Security Functional Components, Version 3.1, Revision 5, April 2017, CCMB-2017-04-002
- [3] Common Criteria, Part 3: Common Criteria for Information Technology Security Evaluation, Part 3: Security Assurance Components, Version 3.1, Revision 5, April 2017, CCMB-2017-04-003
- [4] Common Methodology for Information Technology Security Evaluation, Evaluation Methodology, Version 3.1, Revision 5, April 2017, CCMB-2017-04-004
- [5] Eurosmart Security IC Platform Protection Profile with Augmentation Packages, Version 1.0, BSI-CC-PP-0084-2014.
- [6] AIS31: Functionality classes and evaluation methodology for true (physical) random number generators, Version 1, 25.09.2001, Bundesamt für Sicherheit in der Informationstechnik
- [7] A proposal for: Functionality classes for random number generators, Version 2.0, 18.09.2011, Bundesamt für Sicherheit in der Informationstechnik
- [8] ALGO: Federal Gazette No 19, Notification in accordance with the Electronic Signatures Act and the Electronic Signatures Ordinance (overview of suitable algorithms), Federal Network Agency for Electricity, Gas, Telecommunications, Post and Railway, 2008-11-17
- [9] [FIPS SP800-67] Recommendation for the Triple Data Encryption Algorithm (TDEA) Block Cipher, version 1.1
- [10] [FIPS 197] Advanced Encryption Standard (AES), 2001-11-26
- [11] [ISO/IEC 14888-2:2008] - Information technology -- Security techniques-- Digital signatures with appendix -- Part 2: Integer factorization based mechanisms.
- [12] CC Supporting Document, Mandatory Technical Document, "Application of Attack Potential to Smartcards": version 3.0 (April 2019).
- [13] [ANS X9.62] American National Standard X9.62-2005, Public Key Cryptography for the Financial Services Industry, The Elliptic Curve Digital Signature Algorithm (ECDSA), November 16, 2005.
- [14] [ANS X9.63] American National Standard X9.63-2001, Public Key Cryptography for the Financial Services Industry: Key Agreement and Key Transport Using Elliptic Curve Cryptography, November 20, 2001
- [15] [FIPS PUB 180-3] U.S. Department of Commerce / National Bureau of Standards, Secure Hash Algorithm, FIPS PUB 180-3, 2008-October
- [16] [Brainpool curves] ECC Brainpool Standard Curves and Curve generation, M. Lochter, v1.0, www.ecc-brainpool.org
- [17] [NIST curves] Federal Information Processing Standards Publication FIPS PUB 180-3, Digital Signature Standard; U.S. department of Commerce / National Institute of Standards and Technology (NIST), June 2009
- [18] [SEC-recommended curves] SEC2: Recommended Elliptic Curve Domain Parameters, Certicom Research, v1.0, September 20, 2000.
- [19] [ETSI TS 102 176-1] Electronic Signatures and Infrastructures (ESI); Algorithms and Parameters for Secure Electronic Signatures; Part 1: Hash functions and asymmetric algorithms, 2007-11, version 2.0.0
- [20] [SCA on Prime Gen] T. Finke, M. Gebhardt and W. Schindler, A New Side-Channel Attack on RSA Prime Generation, CHES 2009, LNCS 5747, pp. 141-155, 2009.
- [21] Les règles et recommandations concernant le choix et le dimensionnement de mécanismes cryptographiques. Annexe B1 du RGS 2.0. Version 2.03, 21/02/2014, ANSSI.
http://www.ssi.gouv.fr/uploads/2015/01/RGS_v-2-0_B1.pdf
- [22] PP0084 – Interpretations – v3, 01/06/2016, ANSSI

[23] [ISO 18032] ISO/IEC 18032 Information technology – Security techniques – Prime number generation, 15/01/2005