	Reference <b>D1371562</b>	Release <b>1.0p</b> <small>(Printed copy not controlled: verify the version before using)</small>
	Classification Level <b>Public</b>	Pages <b>61</b>

---

# Security Target Lite

## MultiApp V3.1 144K

## IAS Classic V4.2 CWA

	Reference <b>D1371562</b>	Release <b>1.0p</b> <small>(Printed copy not controlled: verify the version before using)</small>
	Classification Level <b>Public</b>	Pages <b>61</b>

## CONTENT

<b>1. ST INTRODUCTION .....</b>	<b>4</b>
1.1 ST IDENTIFICATION .....	4
1.2 ST OVERVIEW .....	4
1.3 REFERENCES .....	5
1.3.1 External References .....	5
1.3.2 Internal References .....	6
1.4 ACRONYMS .....	6
1.5 GLOSSARY .....	7
1.6 TOE OVERVIEW .....	9
1.6.1 TOE description .....	9
1.7 TOE BOUNDARIES .....	9
1.8 TOE LIFE-CYCLE .....	10
1.8.1 Four phases .....	10
1.8.2 Actors .....	13
1.8.3 Pre-personalization on module at Gemalto site .....	14
1.8.4 Pre-personalization on inlay at Gemalto site .....	15
<b>2. CONFORMANCE CLAIMS .....</b>	<b>16</b>
2.1 CC CONFORMANCE CLAIM .....	16
2.2 PP CLAIM, .....	16
2.3 PACKAGE CLAIM .....	16
<b>3. SECURITY PROBLEM DEFINITION .....</b>	<b>17</b>
3.1 INTRODUCTION .....	17
3.1.1 Assets .....	17
3.1.2 Subjects .....	17
3.1.3 Threat agent .....	17
3.2 ASSUMPTIONS .....	18
3.3 THREATS .....	18
3.4 ORGANIZATIONAL SECURITY POLICIES .....	19
3.5 COMPATIBILITY BETWEEN SECURITY ENVIRONMENTS OF [ST-IAS] AND [ST-PLTF] .....	20
3.5.1 Compatibility between threats of [ST-IAS] and [ST-PLTF] .....	20
3.5.2 Compatibility between OSP of [ST-IAS] and [ST-PLTF] .....	20
3.5.3 Compatibility between assumptions of [ST-IAS] and [ST-PLTF] .....	20
3.6 JUSTIFICATIONS FOR ADDING ASSUMPTIONS ON THE ENVIRONMENT .....	20
3.6.1.1 Additions to [PP-SSCD-KG] .....	20
<b>4. SECURITY OBJECTIVES .....</b>	<b>21</b>
4.1 SECURITY OBJECTIVES FOR THE TOE .....	21
4.1.1 Common to Type 2 and Type 3 .....	21
4.1.2 Type 2 specific .....	22
4.1.3 Type 3 specific .....	22
4.1.4 Extensions .....	22
4.2 SECURITY OBJECTIVES FOR THE OPERATIONAL ENVIRONMENT .....	22
4.2.1 Common to Type 2 and Type 3 .....	23
4.2.2 Specific to Type 2 .....	23
4.3 SECURITY OBJECTIVE RATIONALE .....	24
4.3.1 Threats .....	24
4.3.2 Assumptions .....	26
4.3.3 Organisational security policies .....	26
4.3.4 Compatibility between objectives of [ST-IAS] and [ST-PLTF] .....	27
4.3.4.1 Compatibility between objectives for the TOE .....	27
4.3.4.2 Compatibility between objectives for the environment .....	27
4.3.5 Justifications for adding objectives on the environment .....	27
4.3.5.1 Additions to [PP-SSCD-KG] .....	27

	Reference <b>D1371562</b>	Release <b>1.0p</b> <small>(Printed copy not controlled: verify the version before using)</small>
	Classification Level <b>Public</b>	Pages <b>61</b>

<b>5. EXTENDED COMPONENTS DEFINITION.....</b>	<b>28</b>
<b>6. SECURITY REQUIREMENTS.....</b>	<b>29</b>
6.1 SECURITY FUNCTIONAL REQUIREMENTS FOR THE TOE .....	29
6.1.1 Class Cryptographic Support (FCS).....	29
6.1.2 Class FDP User Data Protection .....	32
6.1.3 Class FIA Identification and Authentication.....	38
6.1.4 Class FMT Security Management.....	41
6.1.5 Class FPT Protection of the Security Functions.....	44
6.1.6 Class FTP Trusted Path/Channel .....	46
6.2 SECURITY ASSURANCE REQUIREMENTS FOR THE TOE.....	48
6.3 SECURITY REQUIREMENTS RATIONALE .....	49
6.3.1 SFR and PP.....	49
6.3.2 Security Functional Requirements Rationale.....	50
6.3.2.1 Security objectives for the TOE.....	50
6.3.2.2 Dependency Rationale .....	54
6.3.3 Security Assurance Requirements Rationale .....	56
6.3.4 Compatibility between SFR of [ST-IAS] and [ST-PLTF] .....	56
<b>7. TOE SUMMARY SPECIFICATION .....</b>	<b>58</b>
7.1 TOE SECURITY FUNCTIONS.....	58
7.1.1 SF provided by IAS Applet.....	58
7.1.2 TSFs provided by the platform.....	59
7.2 TOE SUMMARY SPECIFICATION RATIONALE .....	60
7.2.1 TOE security functions rationale .....	60

## FIGURES

Figure 1: TOE Boundaries.....	10
Figure 2: TOE Personalization .....	11
Figure 3: TOE Operational Use.....	12
Figure 4: LC1: Pre-personalization on module at Gemalto site.....	14
Figure 5: LC3: Pre-personalization on inlay at Gemalto site.....	15

## TABLES

Table 2: Identification of the actors .....	13
Table 3: Threats, Assumptions, Policies vs Security objectives .....	24
Table 4: FCS_CKM.1/SCD refinement .....	29
Table 5: FCS_CKM.1/Session refinement .....	30
Table 6: FCS_CKM.4 refinement.....	30
Table 7: FCS_CKM.4 refinement.....	31
Table 8: FCS_COP.1/CORRESP refinement .....	31
Table 9: FCS_COP.1/DSC refinement .....	32
Table 10: FCS_COP.1/Other refinement .....	32
Table 11: FIA_AFL.1/PERSO refinements.....	38
Table 12: conditions triggering tests.....	46
Table 13: Objective vs SFR rationale .....	50
Table 14: Objective vs SFR rationale .....	52
Table 15: Dependency rationale .....	56
Table 16: TOE security functions list.....	58
Table 17: Security Functions provided by the Multiapp V31 Platform .....	59
Table 18: Rationale table of functional requirements and security functions .....	61

	Reference <b>D1371562</b>	Release <b>1.0p</b> <small>(Printed copy not controlled: verify the version before using)</small>
	Classification Level <b>Public</b>	Pages <b>61</b>

## 1. ST INTRODUCTION

### 1.1 ST IDENTIFICATION

Title:	MultiApp V31 144K IAS CWA Security Target
Version:	V1.0p
ST reference:	D1371562
Origin:	Gemalto
ITSEF:	SERMA Technologies
Certification Body:	ANSSI
Evaluation scheme	FRENCH
Product identification:	IAS Classic V4.2 on MultiApp V31
Security Controllers:	NXP P60D144P VA
TOE identification:	IAS Classic V4.2 on MultiApp V31 144K
TOE documentation:	Guidance document [GUIDE]

The TOE identification is provided by the Card Production Life Cycle Data (CPLCD) of the TOE, located in OTP and in EEPROM. These data are available by executing a dedicated command.

The TOE and the product differ, as further explained in §1.7 TOE boundaries:

- The TOE is the IAS application, with MOC Server, on MultiApp V31 144K
- The MultiApp V31 product also includes 2 applications in ROM.

### 1.2 ST OVERVIEW

The Target of Evaluation (TOE) is composed of the MultiApp V31 platform and the electronic signature application IAS with MOC server.

The platform includes the hardware and the operating system.

The IC is evaluated in conformance with [PP-IC-0035].

The Platform is evaluated in conformance with [PP-JCS-Open].

The IAS application is evaluated in conformance with [PP-SSCD-KG]] and [PP-SSCD-KI],

The main objectives of this ST are:

- To introduce TOE and the IAS application,
- To define the scope of the TOE and its security features,
- To describe the security environment of the TOE, including the assets to be protected and the threats to be countered by the TOE and its environment during the product development, production and usage.
- To describe the security objectives of the TOE and its environment supporting in terms of integrity and confidentiality of application data and programs and of protection of the TOE.
- To specify the security requirements which includes the TOE security functional requirements, the TOE assurance requirements and TOE security functions.

	Reference <b>D1371562</b>	Release <b>1.0p</b> (Printed copy not controlled: verify the version before using)
	Classification Level <b>Public</b>	Pages <b>61</b>

## 1.3 REFERENCES

### 1.3.1 External References

[CC-1]	Common Criteria for Information Technology Security Evaluation Part 1: Introduction and general model, CCMB-2012-09-001, version 3.1 rev 4, September 2012
[CC-2]	Common Criteria for Information Technology Security Evaluation Part 2: Security functional components, CCMB-2012-09-002, version 3.1 rev 4, September 2012
[CC-3]	Common Criteria for Information Technology Security Evaluation Part 3: Security assurance components, CCMB-2012-09-003, version 3.1 rev 4, September 2012
[CEM]	Common Methodology for Information Technology Security Evaluation Methodology CCMB-2012-09-004, version 3.1 rev 4, September 2012
[ST-IC]	[ST-IC-P60D144]
[CR-IC]	[CR-IC-P60D144]
[ST-IC-P60D144]	ST of NXP Secure Smart Card Controller P60D144PVA BSI-DSZ-CC-0845-2012
[CR-IC-P60D144]	Certification Report, BSI-DSZ-CC-0845-2012
[FIPS180-2]	<i>Federal Information Processing Standards Publication 180-2 SECURE HASH STANDARD (+Change Notice to include SHA-224)</i> , U.S. DEPARTMENT OF COMMERCE/National Institute of Standards and Technology, 2002 August 1
[FIPS46-3]	<i>Federal Information Processing Standards Publication FIPS PUB 46-3, DATA ENCRYPTION STANDARD (DES)</i> , U.S. DEPARTMENT OF COMMERCE/National Institute of Standards and Technology, Reaffirmed 1999 October 25
[ISO15946-1]	<i>ISO/IEC 15946: Information technology – Security techniques – Cryptographic techniques based on elliptic curves – Part 1: General</i> , 2002
[ISO15946-2]	<i>ISO/IEC 15946: Information technology – Security techniques – Cryptographic techniques based on elliptic curves – Part 2: Digital Signatures</i> , 2002
[ISO15946-3]	<i>ISO/IEC 15946: Information technology – Security techniques – Cryptographic techniques based on elliptic curves – Part 3: Key establishment</i> , 2002
[ISO7816]	<i>ISO 7816, Identification cards – Integrated circuit(s) cards with contacts, Part 4: Organization, security and commands for interchange</i> , FDIS2004
[ISO9796-2]	<i>ISO/IEC 9797: Information technology – Security techniques – Digital Signature Schemes giving message recovery – Part 2: Integer factorisation based mechanisms</i> , 2002
[ISO9797-1]	<i>ISO/IEC 9797: Information technology – Security techniques – Message Authentication Codes (MACs) – Part 1: Mechanisms using a block cipher</i> , 1999
[PKCS#3]	<i>PKCS #3: Diffie-Hellman Key-Agreement Standard</i> , An RSA Laboratories Technical Note, Version 1.4, Revised November 1, 1993

	Reference <b>D1371562</b>	Release <b>1.0p</b> <small>(Printed copy not controlled: verify the version before using)</small>
	Classification Level <b>Public</b>	Pages <b>61</b>

[PP-IC-0035]	<i>Smartcard IC Platform protection Profile</i> BSI-PP-0035
[CWA-14169]	Protection profiles for secure signature creation device – CWA version
[PP-SSCD-KG]	[CWA-14169-3]
[PP-SSCD-KI]	[CWA-14169-2]
[CWA-14169-2]	Protection Profile – Secure Signature-Creation Device Type2 BSI-PP-0005, Version 1.04, 25 <sup>th</sup> July 2001
[CWA-14169-3]	Protection Profile – Secure Signature-Creation Device Type3 BSI-PP-0006, Version 1.05, 25 <sup>th</sup> July 2001
[PP-JCS-Open]	Java Card System Protection Profile – Open Configuration ANSSI-PP-2010- 03, Version 2.6, April, 19 <sup>th</sup> 2010
[GP211]	Global Platform Card Specification v 2.1.1 - March 2003
[DirectiveEC]	DIRECTIVE 1999/93/EC OF THE EUROPEAN PARLIAMENT AND OF THE COUNCIL of 13 December 1999 on a Community framework for electronic signatures
[EN-14168-2]	Protection profiles for secure signature creation device – Part2 : Device with key generation BSI-CC-PP-0059-2009-MA-01, Version 2.01, January 2012
[EN-14168-3]	Protection profiles for secure signature creation device – Part3: Device with key import BSI-CC-PP-0075-2012, Version 1.02, July 2012

### 1.3.2 Internal References

[ST-PLTF]	D1278582 JCS Security Target - MultiApp V31 DELPHES31
[GUIDE]	IAS V4.2 user guidance Multiapp V31 platform User Guidance

### 1.4 ACRONYMS

CC	Common Criteria
CGA	Certificate generation application
DTBS	Data to be signed
DTBS/R	Data to be signed or its unique representation
EAL	Evaluation Assurance Level
IC	Integrated Circuit
IT	Information Technology
OS	Operating System
PP	Protection Profile
RAD	Reference Authentication Data
SAR	Security Assurance Requirements
SCA	Signature-creation application
SCD	Signature-creation data
SCS	Signature-creation system
SDO	Signed data object

	Reference <b>D1371562</b>	Release <b>1.0p</b> (Printed copy not controlled: verify the version before using)
	Classification Level <b>Public</b>	Pages <b>61</b>

SF	Security Function
SFR	Security functional requirements
SSCD	Secure signature-creation device
ST	Security Target
SVD	Signature-verification data
TOE	Target Of Evaluation
TSF	TOE Security Functionality
VAD	Verification authentication data

## 1.5 GLOSSARY

Term	Definition
Forgery	Fraudulent alteration of any part of the genuine document, e.g. changes to the biographical data or the portrait. [SS]
IC Dedicated Support Software	That part of the IC Dedicated Software (refer to above) which provides functions after TOE Delivery. The usage of parts of the IC Dedicated Software might be restricted to certain phases.
IC Dedicated Test Software	That part of the IC Dedicated Software (refer to above) which is used to test the TOE before TOE Delivery but which does not provide any functionality thereafter.
Impostor	A person who applies for and obtains a document by assuming a false name and identity, or a person who alters his or her physical appearance to represent himself or herself as another person for the purpose of using that person's document. [SS]
Initialisation Data	Any data defined by the TOE Manufacturer and injected into the non-volatile memory by the Integrated Circuits manufacturer (Phase 2). These data are for instance used for traceability and for IC identification I (IC identification data).
Integrated circuit	Electronic component(s) designed to perform processing and/or memory functions. The MultiApp's chip is a integrated circuit.
Personalization	The process by which the portrait, signature and biographical data are applied to the document. [SS]
Personalization Agent	The agent acting on the behalf of the issuing State or organization to personalize the TOE for the holder.
Personalization Agent Authentication Information	TSF data used for authentication proof and verification of the Personalization Agent.
Pre- personalization Data	Any data that is injected into the non-volatile memory of the TOE by the TOE Manufacturer (Phase 2) for traceability of non-personalized TOE's and/or to secure shipment within or between life cycle phases 2 and 3. It contains (but is not limited to) the Personalization Agent Key Pair.
Pre –personalized TOE's chip	TOE's chip equipped with pre-personalization data.
TSF data	Data created by and for the TOE, that might affect the operation of the TOE (CC part 1 [1]).
User data	Data created by and for the user, that does not affect the operation of the TSF (CC part 1 [1]).

	Reference <b>D1371562</b>	Release <b>1.0p</b> <small>(Printed copy not controlled: verify the version before using)</small>
	Classification Level <b>Public</b>	Pages <b>61</b>

---



	Reference <b>D1371562</b>	Release <b>1.0p</b> <small>(Printed copy not controlled: verify the version before using)</small>
	Classification Level <b>Public</b>	Pages <b>61</b>

## 1.6 TOE OVERVIEW

### 1.6.1 TOE description

IAS is a Java Card application that provides a Secure Signature Creation Device – SSCD - as defined in the DIRECTIVE 1999/93/EC of the European Parliament and of the Council of 13 December 1999 on a Community Framework for electronic signatures.

[PP-SSCD] defines protection profiles for SSCD:

- [PP-SSCD-KI] is a protection profile for an SSCD Type 2 with SCD key import and signature creation.
- [PP-SSCD-KG] is a protection profile for an SSCD Type 3 with SCD/SVD key generation and signature creation.

In this document the terminology of [CWA-14169] is used. In particular, the Signatory's Reference Authentication Data (RAD) is the PIN stored in the card and the Signatory's Verification Authentication Data (VAD) is the PIN provided by the user.

The IAS application can be used in contact or contactless mode.

The IAS application supports:

- The import of the SCD via a trusted channel
- The (on-board) generation of SCD/SVD pairs
- The generation of electronic signatures
- The export of the SVD to the certification generation application (CGA)

IAS is aimed to create legal valid signatures and therefore provides mechanisms to ensure the secure signature creation as:

- Authentication of the signatory by PIN or BioPIN,
- Authentication of the administrator (mutual authentication):
  - Symmetric scheme with TDES or AES
  - Asymmetric scheme with Diffie-Hellman based on RSA or elliptic curves
- Integrity of access conditions to protected data (SCD, RAD),
- Integrity of the data to be signed (DTBS),
- External communication protection against disclosure and corruption (secure messaging),
- Access control to commands and data by authorized users.

## 1.7 TOE BOUNDARIES

The Target of Evaluation (TOE) is the Secure Signature Creation Device - SSCD - IAS defined by:

- The underlying Integrated Circuit
- The MultiApp V31 platform (JavaCard platform)
- The IAS Application.

Figure 1: TOE Boundaries gives a description of the TOE and its boundaries.

	Reference <b>D1371562</b>	Release <b>1.0p</b> <small>(Printed copy not controlled: verify the version before using)</small>
	Classification Level <b>Public</b>	Pages <b>61</b>

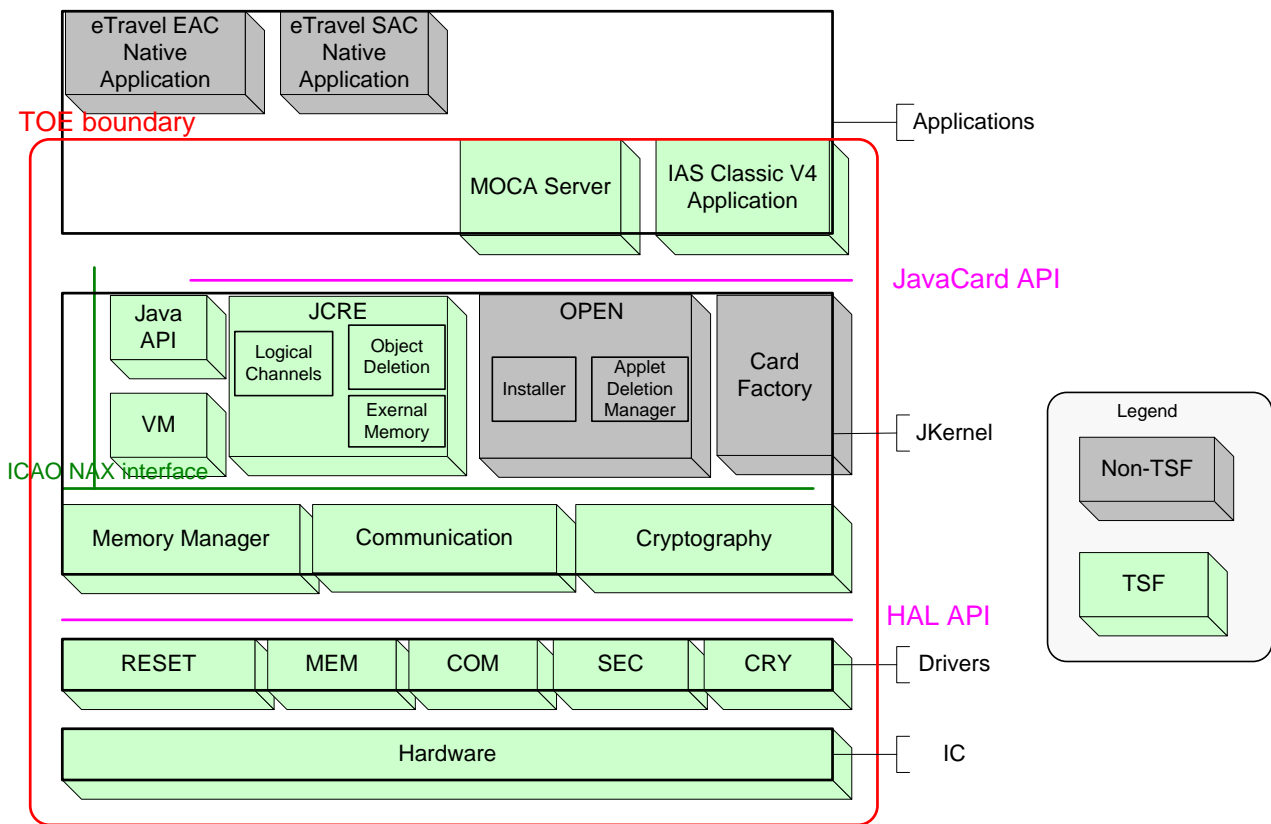

Figure 1: TOE Boundaries

## 1.8 TOE LIFE-CYCLE

### 1.8.1 Four phases

The TOE life cycle is described in terms of the four life cycle phases:

#### Phase 1 “Development”:

The TOE is developed in phase 1. The IC developer develops the integrated circuit, the IC Dedicated Software and the guidance documentation associated with these TOE components.

The Embedded Software developer uses the guidance documentation for the integrated circuit and the guidance documentation for relevant parts of the IC Dedicated Software and develops the IC Embedded Software (operating system), the SSCD application and the guidance documentation associated with these TOE components.

#### Phase 2 “Manufacturing”:

In a first step the TOE integrated circuit is produced containing the chip Dedicated Software and the parts of the chip Embedded Software in the nonvolatile non-programmable memories (ROM). The IC manufacturer writes the IC Identification Data onto the chip to control the IC as SSCD material during the IC manufacturing and the delivery process to the SSCD manufacturer. The IC is securely delivered from the IC manufacturer to the SSCD manufacturer.

The SSCD manufacturer has the following tasks:

- **Initialization:** adding the parts of the IC Embedded Software (NVM ES) to the EEPROM,
- **Pre-personalization:** initialization of the SSCD application,

	Reference <b>D1371562</b>	Release <b>1.0p</b> <small>(Printed copy not controlled: verify the version before using)</small>
	Classification Level <b>Public</b>	Pages <b>61</b>

Phase 3 Personalization of the TOE:

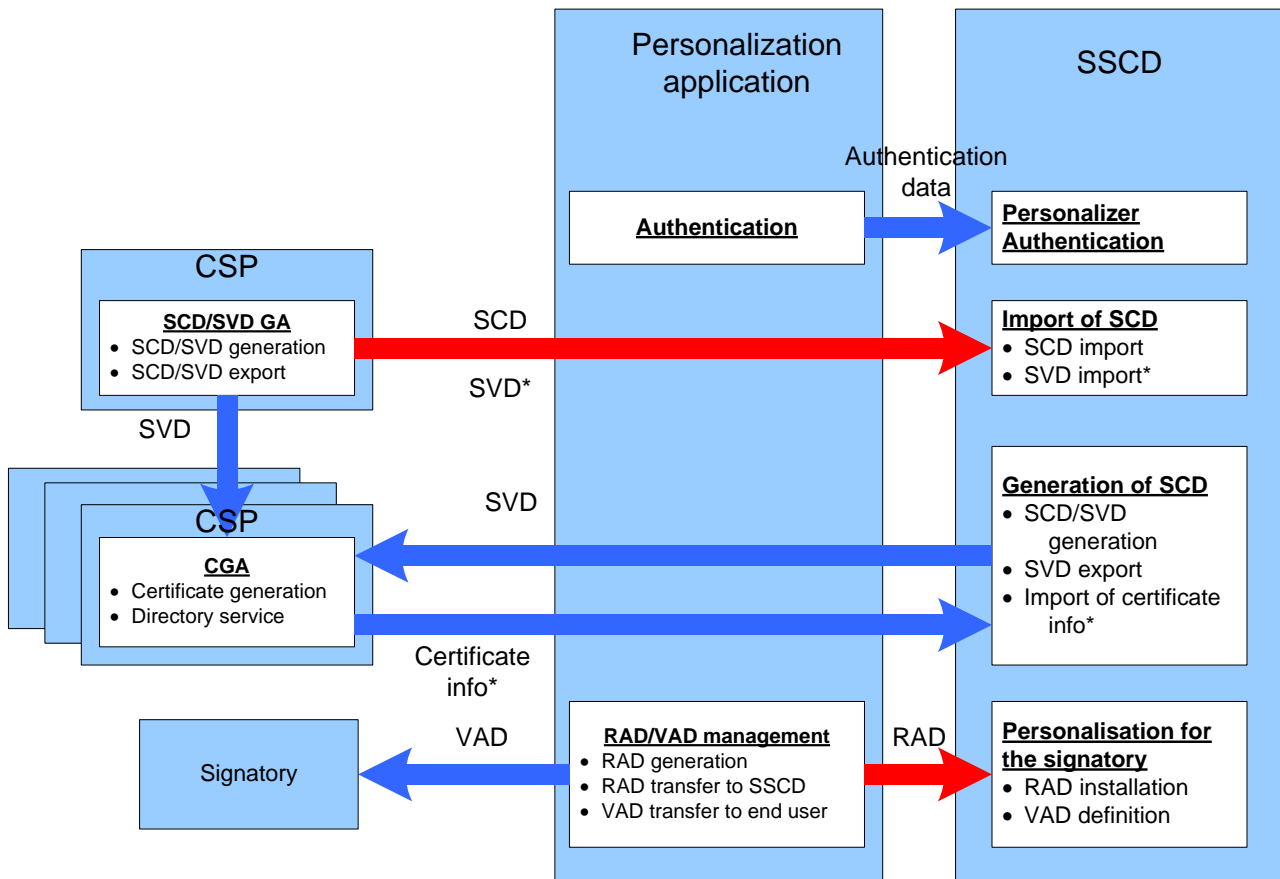

**Figure 2: TOE Personalization**

**RAD Import in the Personalization phase,**

- The Personalizer (Administrator) authenticates himself to the TOE.
- The Personalizer (Administrator) sends the RAD to the TOE.
- The RAD shall also be securely sent to the Signatory.

**SCD Import in the Personalization phase,**

- The Personalizer (Administrator) authenticates himself to the TOE.
- The Personalizer (Administrator) requests the generation of a SCD/SVD key pair on the CSP.
- The SCD / SVD pair is generated.
- The SCD is sent to the TOE.
- The SVD is sent to the CGA.
- The CGA generates the certificate.
- The certificate info is imported into the TOE.

**SCD/SVD generation in the Personalization phase,**

- The Personalizer (Administrator) authenticates himself to the TOE.
- The Personalizer (Administrator) requests the generation of a SCD/SVD key pair on the SSCD.
- The SCD / SVD pair is generated in the TOE.
- The SVD is sent to the CGA.
- The CGA generates the certificate.
- The certificate info is imported into the TOE.



	Reference <b>D1371562</b>	Release <b>1.0p</b> <small>(Printed copy not controlled: verify the version before using)</small>
	Classification Level <b>Public</b>	Pages <b>61</b>

- The SCD is sent to the TOE.
- The SVD is sent to the CGA.
- The CGA generates the certificate.
- The certificate info is imported into the TOE.

Signature Creation in the usage phase,

- The signatory enters his PIN code (VAD) to authenticate himself to the TOE.
- The signatory sends the DTBS or DTBS representation to the TOE.
- The TOE computes the Signature.
- The TOE sends the Signature to the SCA.

## 1.8.2 Actors

Actors	Identification
Integrated Circuit (IC) Developer	NPX
Embedded Software Developer	Gemalto
Integrated Circuit (IC) Manufacturer	NPX
Initializer	Gemalto
Pre-personalizer	Gemalto
Inlay manufacturer (optional)	Gemalto or another Inlay manufacturer
Administrator or Personalization Agent	The agent who personalizes the SSCD for the holder.
Signatory or SSCD Holder	The rightful holder of the TOE for whom the Administrator personalizes the SSCD.

**Table 1: Identification of the actors**

	Reference <b>D1371562</b>	Release <b>1.0p</b> <small>(Printed copy not controlled: verify the version before using)</small>
	Classification Level <b>Public</b>	Pages <b>61</b>

### 1.8.3 Pre-personalization on module at Gemalto site

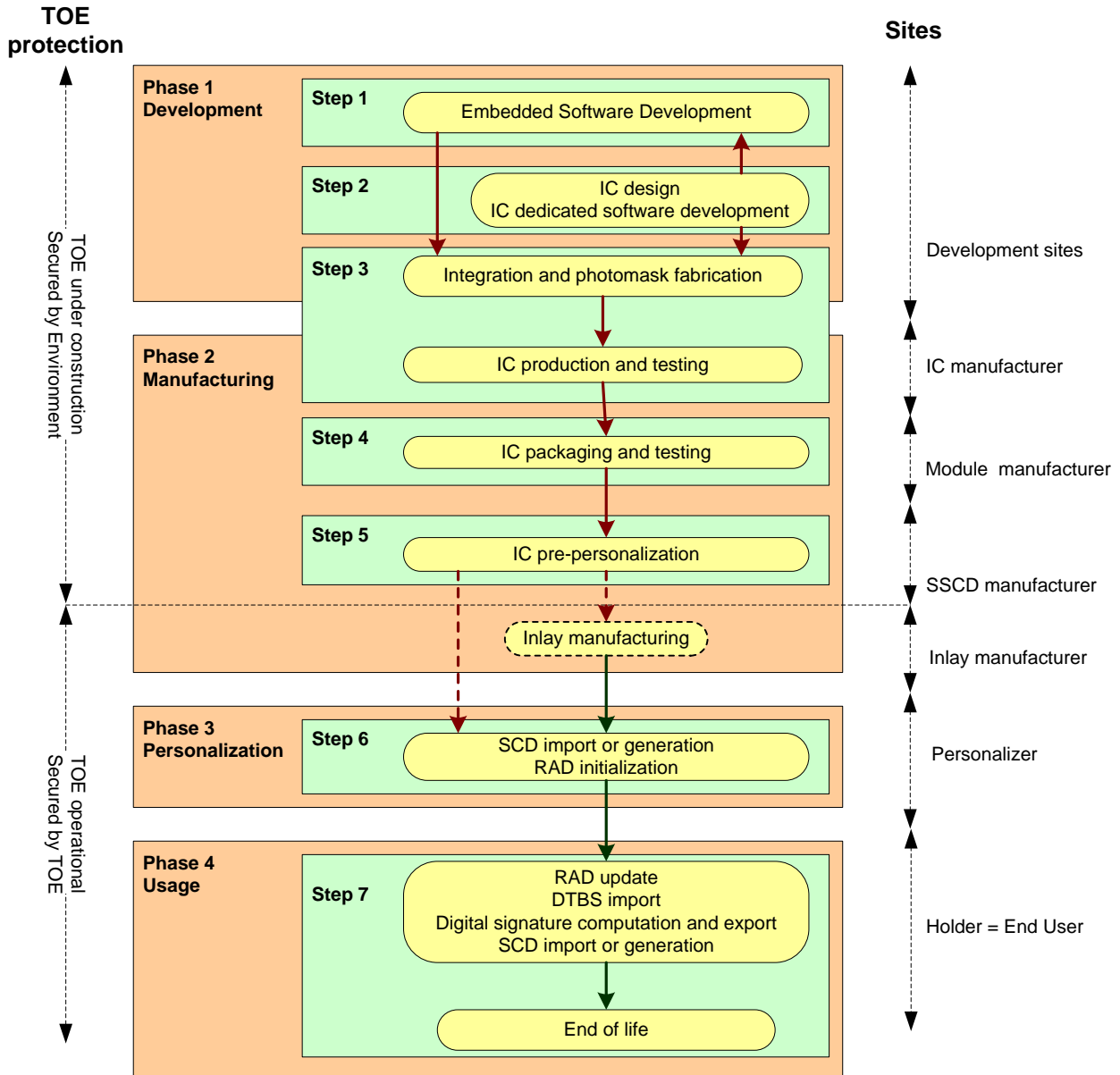
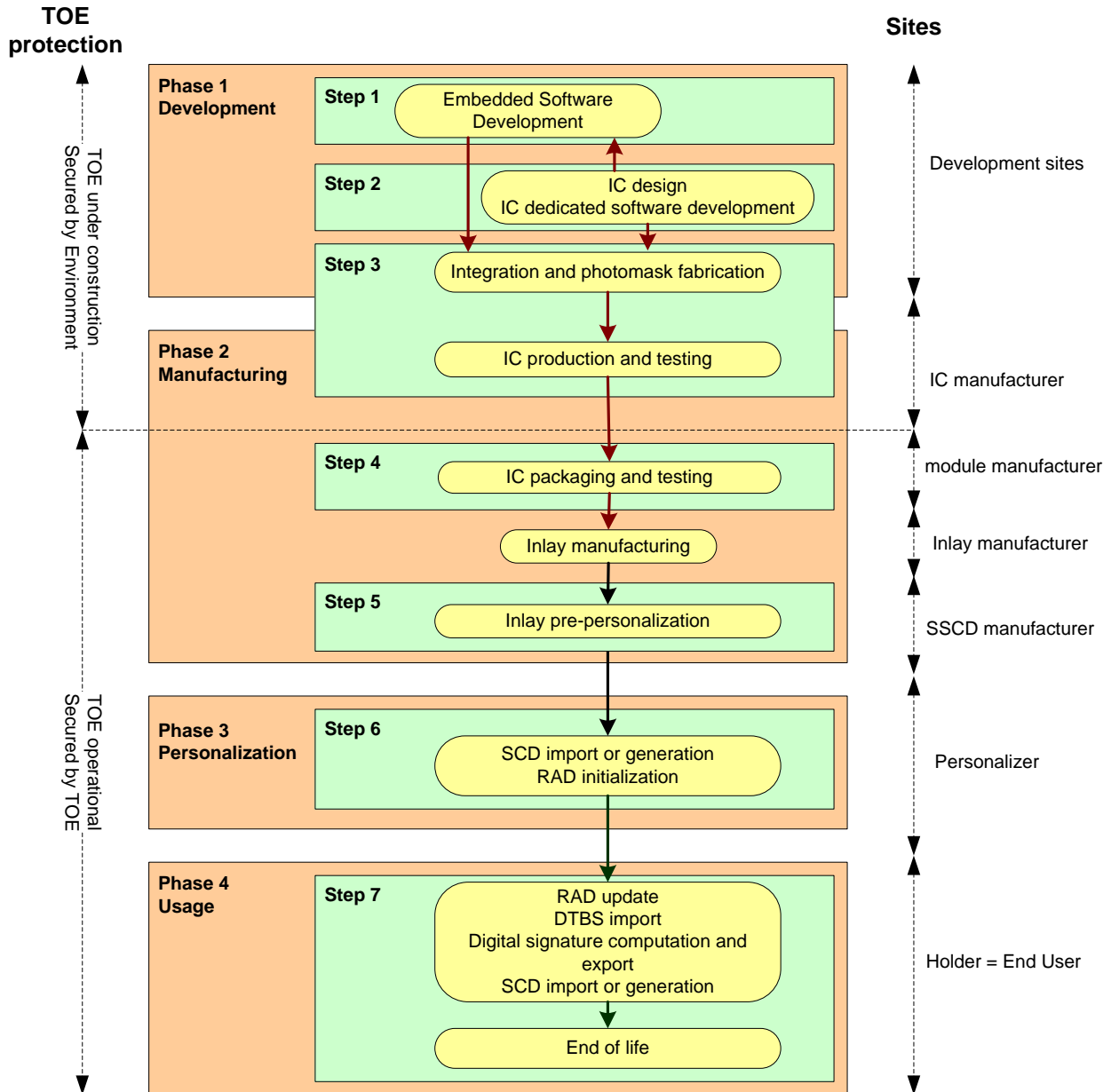

**Figure 4: LC1: Pre-personalization on module at Gemalto site**

Figure 4: LC1: Pre-personalization on module at Gemalto site describes the standard Life Cycle. The module is manufactured at the founder site. It is then shipped, as wafers or modules, to Gemalto site where it is pre-personalized and then shipped to the Personalizer directly or through an Inlay manufacturer. During the shipment from Gemalto to the Personalizer, the module is protected by a diversified key.

	Reference <b>D1371562</b>	Release <b>1.0p</b> <small>(Printed copy not controlled: verify the version before using)</small>
	Classification Level <b>Public</b>	Pages <b>61</b>

### 1.8.4 Pre-personalization on inlay at Gemalto site



**Figure 5: LC3: Pre-personalization on inlay at Gemalto site**

LC3 is another alternative to LC1. *Figure 5: LC3: Pre-personalization on inlay at Gemalto site* describes the Life Cycle when Gemalto wishes to receive inlays instead of modules from the founder. In this case, the founder ships the module to the Inlay manufacturer.

During the shipment from the founder to Gemalto, the module is protected by a diversified key.

	Reference <b>D1371562</b>	Release <b>1.0p</b> <small>(Printed copy not controlled: verify the version before using)</small>
	Classification Level <b>Public</b>	Pages <b>61</b>

## **2. CONFORMANCE CLAIMS**

### **2.1 CC CONFORMANCE CLAIM**

This security target claims conformance to

- [CC-1]
- [CC-2]
- [CC-3]

as follows

- Part 2 extended,
- Part 3 conformant.

The

- [CEM] has to be taken into account.

The evaluation of the TOE uses the result of the CC evaluation of the platform MultiApp V31 claiming conformance to [PP-JCS-Open].

### **2.2 PP CLAIM,**

This MultiApp V31 IAS security target claims strict conformance to the following Protection Profiles:

- [PP-SSCD-KI], which defines security requirements for an SSCD Type 2 with SCD key import and signature creation.
- [PP-SSCD-KG], which defines security requirements for an SSCD Type 3 with SCD/SVD key generation and signature creation.

The evaluation is a composite evaluation and uses the results of the platform CC evaluation evaluated at level EAL 5+.

The TOE also claims conformance to other Protection Profiles. This is described in other Security Targets:

### **2.3 PACKAGE CLAIM**

This ST is conforming to assurance package EAL5 augmented with ALC\_DVS.2 and AVA\_VAN.5 defined in CC part 3 [CC-3].



	Reference <b>D1371562</b>	Release <b>1.0p</b> <small>(Printed copy not controlled: verify the version before using)</small>
	Classification Level <b>Public</b>	Pages <b>61</b>

### 3. SECURITY PROBLEM DEFINITION

#### 3.1 INTRODUCTION

##### 3.1.1 Assets

The assets of the TOE are those defined in [PP-SSCD-KI], [PP-SSCD-KG]. The present Security Target deals with the assets of [PP-SSCD-KI] and [PP-SSCD-KG].  
The assets of [PP-JCS-Open] are studied in [ST-PLTF].

##### D.SCD

SCD: private key used to perform an electronic signature operation (confidentiality of the SCD must be maintained).

##### D.SVD

SVD: public key linked to the SCD and used to perform an electronic signature verification (integrity of the SVD when it is exported must be maintained).

##### D.DTBS

DTBS and DTBS-representation: set of data, or its representation which is intended to be signed (Their integrity must be maintained).

##### D.VAD

VAD: PIN code entered by the End User to perform a signature operation (confidentiality and authenticity of the VAD as needed by the authentication method employed are required)

##### D.SSCD

Signature-creation function of the SSCD using the SCD: (The quality of the function must be maintained so that it can participate to the legal validity of electronic signatures)

##### D.RAD

RAD: Reference PIN code used to identify and authenticate the End User (integrity and confidentiality of RAD must be maintained)

##### D.SIG

Electronic signature: (Unforgeability of electronic signatures must be assured).

##### 3.1.2 Subjects

Subject	Definition
S.User	End user of the TOE which can be identified as S.Admin or S.Signatory
S.Admin	User who is in charge to perform the TOE initialisation, TOE personalisation or other TOE administrative functions.
S.Signatory or S.Sigy	User who holds the TOE and uses it on his own behalf or on behalf of the natural or legal person or entity he represents.

##### 3.1.3 Threat agent

Subject	Definition
---------	------------

	Reference <b>D1371562</b>	Release <b>1.0p</b> <small>(Printed copy not controlled: verify the version before using)</small>
	Classification Level <b>Public</b>	Pages <b>61</b>

S.OFFCARD	Attacker. A human or a process acting on his behalf being located outside the TOE. The main goal of the S.OFFCARD attacker is to access Application sensitive information. The attacker has a <b>high level potential attack</b> and <b>knows no secret</b> .
-----------	---

### 3.2 ASSUMPTIONS

The assumptions describe the security aspects of the environment in which the TOE will be used or is intended to be used.

#### A.CGA

*Trustworthy certification-generation application*

The CGA protects the authenticity of the signatory's name and the SVD in the qualified certificate by an advanced signature of the CSP.

#### A.SCA

*Trustworthy signature-creation application*

The signatory uses only a trustworthy SCA. The SCA generates and sends the DTBS-representation of data the signatory wishes to sign in a form appropriate for signing by the TOE.

#### A.SCD\_Generate

*Trustworthy SCD/SVD generation*

If a party other than the signatory generates the SCD/SVD-pair of a signatory, then

- (a) this party will use a SSCD for SCD/SVD-generation,
- (b) confidentiality of the SCD will be guaranteed until the SCD is under the sole control of the signatory and
- (c) the SCD will not be used for signature-creation until the SCD is under the sole control of the signatory.
- (d) The generation of the SCD/SVD is invoked by authorized users only
- (e) The SSCD Type1 ensures the authenticity of the SVD it has created an exported

### 3.3 THREATS

The TOE is required to counter the threats described hereafter.

A threat agent wishes to abuse the assets either by functional attacks or by environmental manipulation, by specific hardware manipulation, by a combination of hardware and software manipulations or by any other type of attacks.

The threats of the TOE are those defined in [PP-SSCD-KI], [PP-SSCD-KG].The present Security Target deals with the threats of [PP-SSCD-KI] and [PP-SSCD-KG].

The assets of [PP-JCS-Open] are studied in [ST-PLTF].

#### T.Hack\_Phys

*Physical attacks through the TOE interfaces*

An attacker interacts with the TOE interfaces to exploit vulnerabilities, resulting in arbitrary security compromises. This threat addresses all the assets.

#### T.SCD\_Divulg

*Storing ,copying, and releasing of the signature-creation data*

An attacker can store, copy, the SCD outside the TOE. An attacker can release the SCD during generation, storage and use for signature-creation in the TOE.

#### T.SCD\_Derive

*Derive the signature-creation data*

	Reference <b>D1371562</b>	Release <b>1.0p</b> <small>(Printed copy not controlled: verify the version before using)</small>
	Classification Level <b>Public</b>	Pages <b>61</b>

An attacker derives the SCD from public known data, such as SVD corresponding to the SCD or signatures created by means of the SCD or any other data communicated outside the TOE, which is a threat against the secrecy of the SCD.

#### **T.Sig\_Forgery**

##### *Forgery of the electronic signature*

An attacker forges the signed data object maybe together with its electronic signature created by the TOE and the violation of the integrity of the signed data object is not detectable by the signatory or by third parties. The signature generated by the TOE is subject to deliberate attacks by experts possessing a high attack potential with advanced knowledge of security principles and concepts employed by the TOE.

#### **T.Sig\_Repud**

##### *Repudiation of Signatures*

If an attacker can successfully threaten any of the assets, then the non-repudiation of the electronic signature is compromised. This results in the signatory being able to deny having signed data using the SCD in the TOE under his control even if the signature is successfully verified with the SVD contained in his un-revoked certificate.

#### **T.SVD\_Forgery**

##### *Forgery of signature-verification data*

An attacker forges the SVD presented by the TOE to the CGA. This result in loss of SVD integrity in the certificate of the signatory.

#### **T.DTBS\_Forgery**

##### *Forgery of the DTBS-representation*

An attacker modifies the DTBS-representation sent by the SCA. Thus the DTBS-representation used by the TOE for signing does not match the DTBS the signatory intended to sign.

#### **T.SigF\_Misuse**

##### *Misuse of the signature creation function of the TOE*

An attacker misuses the signature-creation function of the TOE to create SDO for data the signatory has not decided to sign. The TOE is subject to deliberate attacks by experts possessing a high attack potential with advanced knowledge of security principles and concepts employed by the TOE.

### **3.4 ORGANIZATIONAL SECURITY POLICIES**

The Secure Signature Creation Device usage is for advanced electronic signature. So it is mandatory to follow the organisational security policy proposed by [PP-SSCD-KI] and [PP-SSCD-KG].

#### **P.CSP\_QCert**

##### *Qualified certificate*

The CSP uses a trustworthy CGA to generate the qualified certificate for the SVD generated by the SSCD. The qualified certificates contains at least the elements defined in Annex I of the Directive, i.e., inter alia the name of the signatory and the SVD matching the SCD implemented in the TOE under sole control of the signatory. The CSP ensures that the use of the TOE is evident with signatures through the certificate or other publicly available information.

#### **P.Qsign**

##### *Qualified electronic signatures*

The signatory uses a signature-creation system to sign data with qualified electronic signatures. The DTBS are presented to the signatory by the SCA. The qualified electronic signature is based on a qualified certificate and is created by a SSCD.

	Reference <b>D1371562</b>	Release <b>1.0p</b> <small>(Printed copy not controlled: verify the version before using)</small>
	Classification Level <b>Public</b>	Pages <b>61</b>

### **P.Sigy\_SSCD**

*TOE as secure signature-creation device*

The TOE implements the SCD used for signature creation under sole control of the signatory. The SCD used for signature generation can practically occur only once.

### **P.Pre-personalisation** *Strong authentication in pre-personalisation*

During pre-personalisation, The TOE protects itself with strong authentication.

## **3.5 COMPATIBILITY BETWEEN SECURITY ENVIRONMENTS OF [ST-IAS] AND [ST-PLTF]**

### **3.5.1 Compatibility between threats of [ST-IAS] and [ST-PLTF]**

T.Hack\_Phys and T.SCD\_Divulg are included in T.Physical

T.SCD\_Derive, T.Sig\_Forgery, T.DTBS\_Forgery, T.Sig\_Repud, T.SVD\_Forgery, and T.SigF\_Misuse are threats specific to [ST-IAS] and they do not conflict with the threats of [ST-PLTF].

We can therefore conclude that the threats of [ST-IAS] and [ST-PLTF] are consistent.

### **3.5.2 Compatibility between OSP of [ST-IAS] and [ST-PLTF]**

P.CSP\_QCert, P.Qsign, and P.Sigy\_SSCD and P.Pre-personalisation are OSP specific to [ST-IAS] and they do not conflict with the OSP of [ST-PLTF].

We can therefore conclude that the OSP of [ST-IAS] and [ST-PLTF] are consistent.

### **3.5.3 Compatibility between assumptions of [ST-IAS] and [ST-PLTF]**

A.CGA, A.SCA, and A.SCD\_Generate are assumptions specific to [ST-IAS] and they do no conflict with the assumptions of [ST-PLTF].

We can therefore conclude that the assumptions of [ST-IAS] and [ST-PLTF] are consistent.

## **3.6 JUSTIFICATIONS FOR ADDING ASSUMPTIONS ON THE ENVIRONMENT**

### **3.6.1.1 Additions to [PP-SSCD-KG]**

The only additional assumption on the environment is A.SCD\_Generate. This assumption deals with the SCD generation when the SCD is generated off-TOE and imported afterwards. These two operations are outside the scope of [PP-SSCD-KG]. Therefore the added assumption does not weaken the TOE.

	Reference <b>D1371562</b>	Release <b>1.0p</b> <small>(Printed copy not controlled: verify the version before using)</small>
	Classification Level <b>Public</b>	Pages <b>61</b>

## 4. SECURITY OBJECTIVES

The security objectives in this Security Target are those named and described in [PP-SSCD-KI] and [PP-SSCD-KG].

They cover the following aspects:

- The security objectives for the TOE,
- The security objectives for the environment.

The security objectives stated in [PP-JCS-Open] can be found in [ST-PLTF].

### 4.1 SECURITY OBJECTIVES FOR THE TOE

#### 4.1.1 Common to Type 2 and Type 3

##### **OT.Lifecycle\_Security**

*Lifecycle security*

The TOE shall detect flaws during the initialization, personalization and operational usage. The TOE shall provide safe destruction techniques for the SCD in case of re-generation or re-import.

##### **OT.SCD\_Secrecy**

*Secrecy of signature-creation data*

The secrecy of the SCD (used for signature generation) is reasonably assured against attacks with a high attack potential.

##### **OT.Sig\_Secure**

*Cryptographic security of the electronic signature*

The TOE generates electronic signatures that cannot be forged without knowledge of the SCD through robust encryption techniques. The SCD cannot be reconstructed using the electronic signatures. The electronic signatures shall be resistant against these attacks, even when executed with a high attack potential.

##### **OT.EMSEC\_Design**

*Provide physical emanations security*

Design and build the TOE in such a way as to control the production of intelligible emanations within specified limits.

##### **OT.Tamper\_ID**

*Tamper detection*

The TOE provides system features that detect physical tampering of a system component, and use those features to limit security breaches.

##### **OT.Tamper\_Resistance**

*Tamper resistance*

The TOE prevents or resists physical tampering with specified system devices and components.

##### **OT.DTBS\_Integrity\_TOE**

*Verification of the DTBS-representation integrity*

The TOE shall verify that the DTBS-representation received from the SCA has not been altered in transit between the SCA and the TOE. The TOE itself shall ensure that the DTBS-representation is not altered by the TOE as well. Note, that this does not conflict with the signature-creation process where the DTBS itself could be hashed by the TOE.

##### **OT.Sigy\_SigF**

	Reference <b>D1371562</b>	Release <b>1.0p</b> <small>(Printed copy not controlled: verify the version before using)</small>
	Classification Level <b>Public</b>	Pages <b>61</b>

*Signature generation function for the legitimate signatory only*

The TOE provides the signature-generation function for the legitimate signatory only and protects the SCD against the use by others. The TOE shall resist attacks with high attack potential.

**OT.SCD\_SVD\_Corresp**

*Correspondence between SVD and SCD*

The TOE shall ensure the correspondence between the SVD and the SCD. The TOE shall verify on demand the correspondence between the SCD stored by the TOE and the SVD if it has been sent to the TOE.

**OT.SVD\_Auth\_TOE**

*TOE ensures authenticity of the SVD*

The TOE provides means to enable the CGA to verify the authenticity of the SVD that has been exported by that TOE.

**4.1.2 Type 2 specific**

**OT.SCD\_Transfer**

*Secure transfer of SCD between SSCD*

The TOE shall ensure the confidentiality of the SCD transferred between SSCDs.

**4.1.3 Type 3 specific**

**OT.Init**

*SCD/SVD generation*

The TOE provides security features to ensure that the generation of the SCD and the SVD is invoked by authorized users only.

**OT.SCD\_Unique**

*Uniqueness of the signature-creation data*

The TOE shall ensure the cryptographic quality of the SCD/SVD pair for the qualified electronic signature. The SCD used for signature generation can practically occur only once and cannot be reconstructed from the SVD. In that context 'practically occur once' means the probability of equal SCDs is negligibly low.

**4.1.4 Extensions**

**OT.Pre-perso\_authentication** *Strong authentication in pre-personalisation*

During pre-personalisation, The TOE protects itself with strong authentication.

**4.2 SECURITY OBJECTIVES FOR THE OPERATIONAL ENVIRONMENT**

This section describes the security objectives for the environment.

The IT environment of the TOE is composed of the Certification Generation Application (CGA) and the Signature Creation Application (SCA).

	Reference <b>D1371562</b>	Release <b>1.0p</b> <small>(Printed copy not controlled: verify the version before using)</small>
	Classification Level <b>Public</b>	Pages <b>61</b>

## 4.2.1 Common to Type 2 and Type 3

### OE.CGA\_Qcert

#### *Generation of qualified certificates*

The CGA generates qualified certificates which include inter alia

- (a) the name of the signatory controlling the TOE,
- (b) the SVD matching the SCD implemented in the TOE under sole control of the signatory,
- (c) the advanced signature of the CSP.

### OE.SVD\_AUTH\_CGA

#### *CGA verifies the authenticity of the SVD*

The CGA verifies that the SSCD is the sender of the received SVD and the integrity of the received SVD. The CGA verifies the correspondence between the SCD in the SSCD of the signatory and the SVD in the qualified certificate.

### OE.HI\_VAD

#### *Protection of the VAD*

If an external device provides the human interface for user authentication, this device will ensure confidentiality and integrity of the VAD as needed by the authentication method employed.

### OE.SCA\_Data\_Intend

#### *Data intended to be signed*

The SCA

- (a) generates the DTBS-representation of the data that has been presented as DTBS and which the signatory intends to sign in a form which is appropriate for signing by the TOE,
- (b) sends the DTBS-representation to the TOE and enables verification of the integrity of DTBS-representation by the TOE,
- (c) attaches the signature produced by the TOE to the data or provides it separately.

## 4.2.2 Specific to Type 2

### OE.SCD\_SVD\_Corresp

#### *Correspondence between SVD and SCD*

The SSCD Type1 shall ensure the correspondence between the SVD and the SCD. The SSVD Type1 shall prove the correspondence between the SCD sent to the TOE and the SVD sent to the CGA or TOE.

### OE.SCD\_Transfer

#### *Secure transfer of SCD between SSCD*

The SSCD Type1 shall ensure the confidentiality of the SCD transferred to the TOE. The SSCD Type1 shall prevent the export of a SCD that already has been used for signature generation by the SSCD Type 2. The SCD shall be deleted from the SSCD Type1 whenever it is exported into the TOE.

### OE.SCD\_Unique

#### *Uniqueness of the signature-creation data*

The SSCD Type1 shall ensure the cryptographic quality of the SCD/SVD pair for the qualified electronic signature. The SCD used for signature generation can practically occur only once and cannot be reconstructed from the SVD. In that context 'practically occur once' means that the probability of equal SCDs is negligible low.



### 4.3 SECURITY OBJECTIVE RATIONALE

Threats - Assumptions – Policies  /	OT.EMSEC_Design	OT.lifecycle_Security	OT.SCD_Transfer	OT.Init	OT.SCD_Secrecy	OT.SCD_SVD_Corresp	OT.SVD_Auth_TOE	OT.Tamper_ID	OT.Tamper_Resistance	OT.SCD-Unique	OT.DTBS_Integrity_TOE	OT.Sigy_SigF	OT.Sig_Secure	OT.Pre-personalisation	OE.CGA_QCert	OE.SVD_Auth_CGA	OE.HI_VAD	OE.SCA_Data_Intend	OE.SCD_SVD_Corresp	OE.SCD_Transfer	OE_SCD_Unique
T.Hack_Phys	X				X			X	X												
T.SCD_Divulg			X		X															X	
T.SCD_Derive										X			X								X
T.SVD_Forgery							X									X					
T.DTBS_Forgery											X							X			
T.SigF_Misuse											X	X				X	X				
T.Sig_Forgery	X	X	X		X	X	X	X	X				X		X	X		X	X	X	
T.Sig_Repud	X	X	X		X	X	X	X	X	X	X	X	X		X	X		X	X	X	
A.CGA															X	X					
A.SCA																		X			
A.SCD_Generate																			X	X	X
P.CSP_Qcert						X									X				X		
P.QSign												X	X		X			X			
P.Sigy_SSCD			X						X		X										X
P.Pre-personalisation													X								

Table 2: Threats, Assumptions, Policies vs Security objectives

#### 4.3.1 Threats

**T.Hack\_Phys (Exploitation of physical vulnerabilities)** deals with physical attacks exploiting physical vulnerabilities of the TOE. *OT.SCD\_Secrecy* preserves the secrecy of the SCD.

*OT.EMSEC\_Design* counters physical attacks through the TOE interfaces or observation of TOE emanations. *OT.Tamper\_ID* and *OT.Tamper\_Resistance* counter the threat *T.Hack\_Phys* by detecting and by resisting tamper attacks.

**T.SCD\_Divulg (Storing and copying and releasing of the signature-creation data)** addresses the threat against the legal validity of electronic signature due to storage and copying of SCD outside the TOE, as expressed in the Directive [1], recital (18). This threat is countered by *OT.SCD\_secrecy*, which assures the secrecy of the SCD used for signature generation.

*OT.SCD\_Transfer* and *OE.SCD\_Transfer* ensure the confidentiality of the SCD transferred between SSCDs.

**T.SCD\_Derive (Derive the signature-creation data)** deals with attacks on the SCD via public known data produced by the TOE. This threat is countered by *OE.SCD\_Unique* that provides cryptographic secure generation of the SCD/SVD pair. *OT.Sig\_Secure* ensures cryptographic secure electronic signatures.



	Reference <b>D1371562</b>	Release <b>1.0p</b> <small>(Printed copy not controlled: verify the version before using)</small>
	Classification Level <b>Public</b>	Pages <b>61</b>

**T.Sig\_Forgery (Forgery of the electronic signature)** deals with non-detectable forgery of the electronic signature. This threat is in general addressed by OT.Sig\_Secure (Cryptographic security of the electronic signature), OE.SCA\_Data\_Intend (SCA sends representation of data intended to be signed), OE.CGA\_QCert (Generation of qualified certificates), OT.SCD\_SVD\_Corresp (Correspondence between SVD and SCD), OT.SVD\_Auth\_TOE (TOE ensures authenticity of the SVD), OE.SVD\_Auth\_CGA (CGA proves the authenticity of the SVD), OT.SCD\_Secrecy (Secrecy of the signature-creation data), OT.SCD\_Transfer (Secure transfer of SCD between SSCD), OT.EMSEC\_Design (Provide physical emanations security), OT.Tamper\_ID (Tamper detection), OT.Tamper\_Resistance (Tamper resistance) and OT.Lifecycle\_Security (Lifecycle security), as follows.

OT.Sig\_Secure ensures by means of robust encryption techniques that the signed data and the electronic signature are securely linked together. OE.SCA\_Data\_Intend provides that the methods used by the SCA (and therefore by the verifier) for the generation of the DTBS-representation is appropriate for the cryptographic methods employed to generate the electronic signature. The combination of OE.CGA\_QCert, OT.SCD\_SVD\_Corresp, OT.SVD\_Auth\_TOE, and OE.SVD\_Auth\_CGA provides the integrity and authenticity of the SVD that is used by the signature verification process. OT.Sig\_Secure, OT.SCD\_Secrecy, OT.SCD\_Transfer, OT.EMSEC\_Design, OT.Tamper\_ID, OT.Tamper\_Resistance, and OT.Lifecycle\_Security ensure the confidentiality of the SCD implemented in the signatory's SSCD and thus prevent forgery of the electronic signature by means of knowledge of the SCD.

**T.Sig\_Repud (Repudiation of electronic signatures)** deals with the repudiation of signed data by the signatory, although the electronic signature is successfully verified with the SVD contained in his unrevoked certificate. This threat is in general addressed by OE.CGA\_QCert (Generation of qualified certificates), OT.SVD\_Auth\_TOE (TOE ensures authenticity of the SVD), OE.SVD\_Auth\_CGA (CGA proves the authenticity of the SVD), OT.SCD\_SVD\_Corresp (Correspondence between SVD and SCD), OT.SCD\_Unique (Uniqueness of the signature creation data), OT.SCD\_Transfer (Secure transfer of SCD between SSCD), OT.SCD\_Secrecy (Secrecy of the signature-creation data), OT.EMSEC\_Design (Provide physical emanations security), OT.Tamper\_ID (Tamper detection), OT.Tamper\_Resistance (Tamper resistance), OT.Lifecycle\_Security (Lifecycle security), OT.Sigy\_SigF (Signature generation function for the legitimate signatory only), OT.Sig\_Secure (Cryptographic security of the electronic signature), OE.SCA\_Data\_Intend (SCA sends representation of data intended to be signed) and OT.DTBS\_Integrity\_TOE (Verification of the DTBS-representation integrity).

OE.CGA\_QCert ensures qualified certificates which allow to identify the signatory and thus to extract the SVD of the signatory. OE.CGA\_QCert, OT.SVD\_Auth\_TOE and OE.SVD\_Auth\_CGA ensure the integrity of the SVD. OE.CGA\_QCert and OT.SCD\_SVD\_Corresp ensure that the SVD in the certificate correspond to the SCD that is implemented by the SSCD of the signatory. OT.SCD\_Unique provides that the signatory's SCD can practically occur just once. OT.Sig\_Secure, OT.SCD\_Transfer, OT.SCD\_Secrecy, OT.Tamper\_ID, OT.Tamper\_Resistance, OT.EMSEC\_Design, and OT.Lifecycle\_Security ensure the confidentiality of the SCD implemented in the signatory's SSCD. OT.Sigy\_SigF provides that only the signatory may use the TOE for signature generation. OT.Sig\_Secure ensures by means of robust cryptographic techniques that valid electronic signatures may only be generated by employing the SCD corresponding to the SVD that is used for signature verification and only for the signed data. OE.SCA\_Data\_Intend and OT.DTBS\_Integrity\_TOE ensure that the TOE generates electronic signatures only for DTBS-representations that the signatory has decided to sign.

**T.SVD\_Forgery (Forgery of the signature-verification data)** deals with the forgery of the SVD exported by the TOE to the CGA for the generation of the certificate. T.SVD\_Forgery is addressed by OT.SVD\_Auth\_TOE, which ensures that the TOE sends the SVD in a verifiable form to the CGA, as well as by OE.SVD\_Auth\_CGA, which provides verification of SVD authenticity by the CGA.

	Reference <b>D1371562</b>	Release <b>1.0p</b> <small>(Printed copy not controlled: verify the version before using)</small>
	Classification Level <b>Public</b>	Pages <b>61</b>

**T.DTBS\_Forgery (Forgery of the DTBS-representation)** addresses the threat arising from modifications of the DTBS-representation sent to the TOE for signing which then does not correspond to the DTBS-representation corresponding to the DTBS the signatory intends to sign. The TOE counters this threat by the means of OT.DTBS\_Integrity\_TOE by verifying the integrity of the DTBS-representation. The TOE IT environment addresses T.DTBS\_Forgery by the means of OE.SCA\_Data\_Intend.

**T.SigF\_Misuse (Misuse of the signature-creation function of the TOE)** addresses the threat of misuse of the TOE signature-creation function to create SDO by others than the signatory to create SDO for data the signatory has not decided to sign, as required by the Directive [1], Annex III, paragraph 1, literal (c). This threat is addressed by the OT.Sigy\_SigF (Signature generation function for the legitimate signatory only), OE.SCA\_Data\_Intend (Data intended to be signed), OT.DTBS\_Integrity\_TOE (Verification of the DTBS-representation integrity), and OE.HI\_VAD (Protection of the VAD) as follows:

OT.Sigy\_SigF ensures that the TOE provides the signature-generation function for the legitimate signatory only. OE.SCA\_Data\_Intend ensures that the SCA sends the DTBS-representation only for data the signatory intends to sign. The combination of OT.DTBS\_Integrity\_TOE and OE.SCA\_Data\_Intend counters the misuse of the signature generation function by means of manipulation of the channel between the SCA and the TOE. If the SCA provides the human interface for the user authentication, OE.HI\_VAD provides confidentiality and integrity of the VAD as needed by the authentication method employed.

### 4.3.2 Assumptions

**A.CGA (Trustworthy certification-generation application)** establishes the protection of the authenticity of the signatory's name and the SVD in the qualified certificate by the advanced signature of the CSP by means of the CGA. This is addressed by OE.CGA\_QCert (Generation of qualified certificates), which ensures the generation of qualified certificates, and by OE.SVD\_Auth\_CGA (CGA proves the authenticity of the SVD), which ensures the verification of the integrity of the received SVD and the correspondence between the SVD and the SCD that is implemented by the SSCD of the signatory.

**A.SCA (Trustworthy signature-creation application)** establishes the trustworthiness of the SCA according to the generation of DTBS-representation. This is addressed by OE.SCA\_Data\_Intend (Data intended to be signed) which ensures that the SCA generates the DTBS-representation of the data that has been presented to the signatory as DTBS and which the signatory intends to sign in a form which is appropriate for being signed by the TOE.

**A.SCD\_Generate Trustworthy SCD/SVD generation** establishes a trustworthy SCD/SVD pair. This means that the SCD must be unique, objective met by OE.SCD\_Unique, that the SCD and the SVD must correspond, objective met by OE.SCD\_SVD\_Corresp. The secrecy of the SCD must be maintained while it is transferred to the TOE before being deleted, OE.SCD\_Transfer.

### 4.3.3 Organisational security policies

**P.CSP\_QCert (CSP generates qualified certificates)** establishes the qualified certificate for the signatory and provides that the SVD matches the SCD that is implemented in the SSCD under sole control of this signatory. On SCD/SVD correspondence, this OSP is addressed by OT.SCD\_SVD\_Corresp and OE.SCD\_SVD\_Corresp. In the IT environment, this OSP is addressed by OE.CGA\_QCert for generation of qualified certificates by the CGA, respectively.

	Reference <b>D1371562</b>	Release <b>1.0p</b> (Printed copy not controlled: verify the version before using)
	Classification Level <b>Public</b>	Pages <b>61</b>

**P.QSign (Qualified electronic signatures)** provides that the TOE and the SCA may be employed to sign data with qualified electronic signatures, as defined by the Directive [1], article 5, paragraph 1. Directive [1], recital (15) refers to SSCDs to ensure the functionality of advanced signatures. The requirement of qualified electronic signatures being based on qualified certificates is addressed by OE.CGA\_QCert. OE.SCA\_Data\_Intend ensures that the SCA presents the DTBS to the signatory and sends the DTBS-representation to the TOE. OT.Sig\_Secure and OT.Sigy\_SigF address the generation of advanced signatures by the TOE.

**P.Sigy\_SSCD (TOE as secure signature-creation device)** establishes the TOE as secure signature-creation device of the signatory with practically unique SCD. This OSP is addressed by OT.Sigy\_SigF that ensures that the SCD is under sole control of the signatory, and OE.SCD\_Unique that ensures that the cryptographic quality of the SCD/SVD pair for the qualified electronic signature.

Additionally, for the SSCD Type 3: OT.Init ensures that generation of the SCD/SVD pair is restricted to authorised users.

**P.Pre-personalisation (Strong authentication in pre-personalisation)** requests a strong authentication before accessing the SSCD. This is directly addressed by OT.Pre-personalisation.

#### 4.3.4 Compatibility between objectives of [ST-IAS] and [ST-PLTF]

##### 4.3.4.1 Compatibility between objectives for the TOE

OT.EMSEC\_Design, OT.Lifecycle\_Security, OT.SCD\_Secrecy, OT.Tamper\_ID, OT.Tamper\_Resistance, and OT.DTBS\_Integrity\_TOE deal with physical protection of the TOE. These are supported by O.SCP.IC.

OT.SCD\_SVD\_Corresp, OT.SVD\_Auth\_TOE, OT.SCD\_Transfer, OT.Init, OT.SCD\_Unique, and OT.Pre-personalisation are objectives specific to [ST-IAS] and they do not conflict with the objectives of [ST-PLTF].

We can therefore conclude that the objectives for the TOE of [ST-IAS] and [ST-PLTF] are consistent.

##### 4.3.4.2 Compatibility between objectives for the environment

OE.CGA\_QCert, OE.SVD\_Auth\_CGA, OE.HI\_VAD, OE.SCA\_Data\_Intend, OE.SCD\_SVD\_Corresp, OE.SCD\_Transfer, and OE.SCD\_Unique are objectives specific to [ST-IAS] and they do not conflict with the objectives of [ST-PLTF].

We can therefore conclude that the objectives for the environment of [ST-IAS] and [ST-PLTF] are consistent.

#### 4.3.5 Justifications for adding objectives on the environment

##### 4.3.5.1 Additions to [PP-SSCD-KG]

The only additional objectives on the environment are: OE.SCD\_SVD\_Corresp, OE.SCD\_Transfer, OE.SCD\_Unique. These objectives request the environment to perform several operations when the SCD is generated off-TOE and imported afterwards. These two operations are outside the scope of [PP-SSCD-KG]. Therefore the added objectives on the environment do not weaken the TOE.

	Reference <b>D1371562</b>	Release <b>1.0p</b> <small>(Printed copy not controlled: verify the version before using)</small>
	Classification Level <b>Public</b>	Pages <b>61</b>

## 5. EXTENDED COMPONENTS DEFINITION

This ST uses one component defined as extensions to CC part 2: FPT\_EMS.1 which is defined as FPT\_EMSEC.1 in protection profile [PP-SSCD-KI] and [PP-SSCD-KG].

The additional family FPT\_EMS (TOE Emanation) of the Class FPT (Protection of the TSF) is defined here to describe the IT security functional requirements of the TOE. The TOE shall prevent attacks against the TOE and other secret data where the attack is based on external observable physical phenomena of the TOE. Examples of such attacks are evaluation of TOE's electromagnetic radiation, simple power analysis (SPA), differential power analysis (DPA), timing attacks, etc. This family describes the functional requirements for the limitation of intelligible emanations which are not directly addressed by any other component of CC part 2 [CC-2].

The family "TOE Emanation (FPT\_EMS)" is specified as follows.

Family behavior

This family defines requirements to mitigate intelligible emanations.

Component levelling:

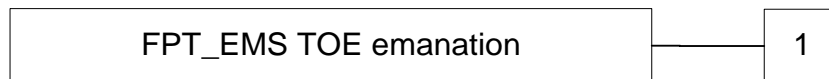

FPT\_EMS.1 TOE emanation has two constituents:

FPT\_EMS.1.1 Limit of Emissions requires to not emit intelligible emissions enabling access to TSF data or user data.

FPT\_EMS.1.2 Interface Emanation requires to not emit interface emanation enabling access to TSF data or user data.

Management: FPT\_EMS.1  
There are no management activities foreseen.

Audit: FPT\_EMS.1  
There are no actions defined to be auditable.

<b>FPT_EMS.1 TOE Emanation</b>
--------------------------------

Hierarchical to: No other components.

Dependencies: No other components.

<b>FPT_EMS.1.1</b>	The TOE shall not emit [assignment: types of emissions] in excess of [assignment: specified limits] enabling access to [assignment: list of types of TSF data] and [assignment: list of types of user data].
<b>FPT_EMS.1.2</b>	The TSF shall ensure [assignment: type of users] are unable to use the following interface [assignment: type of connection] to gain access to [assignment: list of types of TSF data] and [assignment: list of types of user data].

	Reference <b>D1371562</b>	Release <b>1.0p</b> <small>(Printed copy not controlled: verify the version before using)</small>
	Classification Level <b>Public</b>	Pages <b>61</b>

## 6. SECURITY REQUIREMENTS

### 6.1 SECURITY FUNCTIONAL REQUIREMENTS FOR THE TOE

This chapter defines the security functional requirements for the TOE using functional requirements components as specified in [PP-SSCD-KI] and [PP-SSCD-KG].

[ST-PLTF] deals with the security functional requirements of [PP-JCS-Open].

Definition of security attributes:

The security attributes for the subjects, TOE components and related status are:

Groups of security attributes [USER, SUBJECT OR OBJECT THE ATTRIBUTE IS ASSOCIATED WITH]	ATTRIBUTES	ATTRIBUTES STATUS
<b>GENERAL ATTRIBUTE GROUP</b>		
[User]	ROLE	ADMINISTRATOR, SIGNATORY
<b>INITIALISATION ATTRIBUTE GROUP</b>		
[USER]	SCD/SVD MANAGEMENT	AUTHORISED / NOT AUTHORISED
[SCD]	SECURE SCD IMPORT ALLOWED	No/YES
<b>SIGNATURE-CREATION ATTRIBUTE GROUP</b>		
[SCD ]	SCD OPERATIONAL	No/YES
[DTBS]	SENT BY AN AUTHORISED SCA	No/YES

#### 6.1.1 Class Cryptographic Support (FCS)

##### FCS\_CKM.1/SCD Cryptographic key generation for SCD/SVD pair

Hierarchical to: No other components  
 Dependencies: [FCS\_CKM.2 Cryptographic key distribution or  
 FCS\_COP.1 Cryptographic operation]  
 FCS\_CKM.4 Cryptographic key destruction

FCS\_CKM.1.1 The TSF shall generate cryptographic keys in accordance with a specified cryptographic key generation algorithm [*assignment: cryptographic key generation algorithm*] and specified cryptographic key sizes [*assignment: cryptographic key sizes*] that meet the following: [*assignment: list of standards*].

iteration	algorithm	Key size	standards
/RSA	<b>RSA CRT key generation</b>	<b>1024, 1536, 2048</b>	<b>none (generation of random numbers and Miller- Rabin primality testing)</b>
/ECC	<b>ECC key generation</b>	<b>160, 224, 256, 384, 512, 521</b>	<b>None</b>

**Table 3: FCS\_CKM.1/SCD refinement**

Application note: Type 3 only  
 Application note:

	Reference <b>D1371562</b>	Release <b>1.0p</b> (Printed copy not controlled: verify the version before using)
	Classification Level <b>Public</b>	Pages <b>61</b>

FCS\_CKM.1/SCD is named FCS\_CKM.1 in [PP-SSCD-KI] and [PP-SSCD-KG]. The new naming clarifies the purpose of the SFR and allows for the introduction of FCS\_CKM.1/SCD.

### FCS\_CKM.1/Session Cryptographic key generation for session keys

Hierarchical to: No other components  
 Dependencies: [FCS\_CKM.2 Cryptographic key distribution or FCS\_COP.1 Cryptographic operation]  
 FCS\_CKM.4 Cryptographic key destruction

FCS\_CKM.1.1 /Session The TSF shall generate cryptographic keys in accordance with a specified cryptographic key generation algorithm [*assignment: cryptographic key generation algorithm*] and specified cryptographic key sizes [*assignment: cryptographic key sizes*] that meet the following: [*assignment: list of standards*].

iteration	algorithm	Key size	standards
/TDES	<b>TDES session key generation</b>	<b>112</b>	<b>[ISO7816], [PKCS#3] DH.</b>
/AES	<b>AES session key generation</b>	<b>128</b>	<b>[ISO7816], [PKCS#3] DH, [IEEE-P1363] ECDH, [IEEE-P1363] ECDHC</b>

**Table 4: FCS\_CKM.1/Session refinement**

### FCS\_CKM.4/SCD Cryptographic key destruction

Hierarchical to: No other components  
 Dependencies: [FDP\_ITC.1 Import of user data without security attributes, or FDP\_ITC.2 Import of user data with security attributes, or FCS\_CKM.1 Cryptographic key generation]

FCS\_CKM.4.1 /SCD The TSF shall destroy cryptographic keys in accordance with a specified cryptographic key destruction method **Secure erasing of the value** that meets the following: **None**.

iteration	when
/RSA	new SCD generation or import /signer's will
/ECC	new SCD generation or import /signer's will

**Table 5: FCS\_CKM.4 refinement**

Application note:

FCS\_CKM.4/SCD is named FCS\_CKM.4 in [PP-SSCD-KI] and [PP-SSCD-KG]. The new naming clarifies the purpose of the SFR and allows for the introduction of FCS\_CKM.4/SCD.

### FCS\_CKM.4/Session Cryptographic key destruction

Hierarchical to: No other components  
 Dependencies: [FDP\_ITC.1 Import of user data without security attributes, or FDP\_ITC.2 Import of user data with security attributes, or FCS\_CKM.1 Cryptographic key generation]



	Reference <b>D1371562</b>	Release <b>1.0p</b> <small>(Printed copy not controlled: verify the version before using)</small>
	Classification Level <b>Public</b>	Pages <b>61</b>

FCS\_CKM.4.1 /Session The TSF shall destroy cryptographic keys in accordance with a specified cryptographic key destruction method **Secure erasing of the value** that meets the following: **None**.

iteration	when
/TDES	End of session
/AES	End of session

**Table 6: FCS\_CKM.4 refinement**

### FCS\_COP.1/CORRESP Cryptographic operation – SCD/SVD correspondence verification

Hierarchical to: No other components  
 Dependencies: [FDP\_ITC.1 Import of user data without security attributes, or FDP\_ITC.2 Import of user data with security attributes, or FCS\_CKM.1 Cryptographic key generation] FCS\_CKM.4 Cryptographic key destruction

FCS\_COP.1.1 /CORRESP The TSF shall perform SCD/SVD correspondence verification in accordance with a specified cryptographic algorithm [*assignment: cryptographic algorithm*] and cryptographic key sizes [*assignment: cryptographic key sizes*] that meet the following: [*assignment: list of standards*].

iteration	algorithm	key size	standards
/CORRESP-RSA	<b>RSA CRT key generation</b>	<b>1024, 1536, 2048</b>	<b>none (generation of random numbers and Miller-Rabin primality testing)</b>
/CORRESP-ECC	<b>ECC key generation</b>	<b>160, 224, 256, 384, 512, 521</b>	<b>None</b>

**Table 7: FCS\_COP.1/CORRESP refinement**

### FCS\_COP.1/DSC Cryptographic operation – Digital Signature Creation

Hierarchical to: No other components  
 Dependencies: [FDP\_ITC.1 Import of user data without security attributes, or FDP\_ITC.2 Import of user data with security attributes, or FCS\_CKM.1 Cryptographic key generation] FCS\_CKM.4 Cryptographic key destruction

FCS\_COP.1.1 /DSC The TSF shall perform digital signature creation in accordance with a specified cryptographic algorithm [*assignment: cryptographic algorithm*] and cryptographic key sizes [*assignment: cryptographic key sizes*] that meet the following: [*assignment: list of standards*].

iteration	operation	algorithm	key size	standards
/DSC-RSA	signature	<b>RSA CRT</b>	<b>1024, 1536, 2048, 3072, and 4096</b>	<b>[ISO9796-2] RSA SHA PKCS#1 v1.5 RSA PSS SHA PKCS#1</b>

	Reference <b>D1371562</b>	Release <b>1.0p</b> (Printed copy not controlled: verify the version before using)
	Classification Level <b>Public</b>	Pages <b>61</b>

iteration	operation	algorithm	key size	standards
/DSC-ECC	signature	<b>ECC</b>	<b>224, 256, 384, 512, and 521</b>	<b>[TR-03111] ECDSA SHA</b>

**Table 8: FCS\_COP.1/DSC refinement**

Application note:

FCS\_COP.1/DSC is named in FCS\_COP.1/SIGNING [PP-SSCD-KI] and [PP-SSCD-KG].

### FCS\_COP.1/Session Cryptographic operation – Other operations

Hierarchical to: No other components

Dependencies: [FDP\_ITC.1 Import of user data without security attributes, or FDP\_ITC.2 Import of user data with security attributes, or FCS\_CKM.1 Cryptographic key generation] FCS\_CKM.4 Cryptographic key destruction

FCS\_COP.1.1 /Session The TSF shall perform [assignment: cryptographic operations] in accordance with a specified cryptographic algorithm [assignment: cryptographic algorithm] and cryptographic key sizes [assignment: cryptographic key sizes] that meet the following: [assignment: list of standards].

iteration	operation	algorithm	key size	standards
/ENC-TDES	<b>Encryption &amp; decryption</b>	<b>TDES</b>	<b>112</b>	<b>[SP800-67]</b>
/ENC-AES	<b>Encryption &amp; decryption</b>	<b>AES</b>	<b>128</b>	<b>[FIPS197] AES 128 NOPAD</b>
/MAC-TDES	<b>MAC computation &amp; Verification</b>	<b>TDES</b>	<b>112</b>	<b>[SP800-67] [ISO9797-1] DES MAC ISO9797-1 M2</b>
/MAC-AES	<b>MAC computation &amp; Verification</b>	<b>AES</b>	<b>128</b>	<b>[FIPS197] AES 128 NOPAD</b>

**Table 9: FCS\_COP.1/Other refinement**

## 6.1.2 Class FDP User Data Protection

### FDP\_ACC.1 Subset access control

Hierarchical to: No other components

Dependencies: FDP\_ACF.1 Security attribute based access control

FDP\_ACC.1.1 /Initialisation SFP The TSF shall enforce the Initialisation SFP on Generation of SCD/SCD pair by User.

Application note: Type 3 only

FDP\_ACC.1.1 /SVD transfer SFP The TSF shall enforce the SVD transfer SFP on import and on export of SVD by User.

**Application note:**



	Reference <b>D1371562</b>	Release <b>1.0p</b> (Printed copy not controlled: verify the version before using)
	Classification Level <b>Public</b>	Pages <b>61</b>

When SCD is imported into the TOE, FDP\_ACC.1/SVD Transfer SFP will be required only, if the TOE is to import the SVD from a SSCD Type1 so it will be exported to the CGA for certification. This is not the case in this TOE. (Type 2)

When SCD is generated in the TOE, FDP\_ACC.1/SVD Transfer SFP will be required to export the SVD to the CGA for certification. (Type 3).

FDP\_ACC.1.1            The TSF shall enforce the SCD Import SFP on Import of SCD by User.  
/SCD Import SFP

Application note: Type 2 only.

FDP\_ACC.1.1            The TSF shall enforce the Personalisation SFP on Creation of RAD by Administrator.  
/Personalisation SFP

FDP\_ACC.1.1            The TSF shall enforce the Signature-creation SFP on Sending of DTBS-representation by SCA and Signing of DTBS-representation by Signatory.  
/Signature-creation SFP

#### **FDP\_ACF.1 Security attribute based access control**

Hierarchical to:    No other components  
Dependencies:      FDP\_ACC.1 Subset access control  
                          FMT\_MSA.3 Static attribute initialization

#### **Initialisation SFP**

FDP\_ACF.1.1            The TSF shall enforce the Initialisation SFP to objects based on the following:  
/Initialisation        General attribute group and Initialisation attribute group  
SFP

Application note: Type 3 only.

FDP\_ACF.1.2            The TSF shall enforce the following rules to determine if an operation among controlled subjects and controlled objects is allowed:  
/Initialisation        The user with the security attribute "role" set to "Administrator" or set to "Signatory" and with the security attribute "SCD / SVD management" set to "authorized" is allowed to generate SCD/SVD pair.  
SFP

FDP\_ACF.1.3            The TSF shall explicitly authorize access of subjects to objects based on the following additional rules: none.  
/Initialisation          
SFP

FDP\_ACF.1.4            The TSF shall explicitly deny access of subjects to objects based on the following additional rules:  
/Initialisation        The user with the security attribute "role" set to "Administrator" or set to "Signatory" and with the security attribute "SCD / SVD management" set to "not authorized" is not allowed to generate SCD/SVD pair.  
SFP

#### **SVD Transfer SFP**

	Reference <b>D1371562</b>	Release <b>1.0p</b> <small>(Printed copy not controlled: verify the version before using)</small>
	Classification Level <b>Public</b>	Pages <b>61</b>

- FDP\_ACF.1.1 /SVD\_Transfer The TSF shall enforce the SVD Transfer SFP to objects based on the following: General attribute group.
- FDP\_ACF.1.2 /SVD\_Transfer The TSF shall enforce the following rules to determine if an operation among controlled subjects and controlled objects is allowed: The user with the security attribute “role” set to “Administrator” or “Signatory” is allowed to export SVD.
- FDP\_ACF.1.3 /SVD\_Transfer The TSF shall explicitly authorize access of subjects to objects based on the following additional rules: none.
- FDP\_ACF.1.4 /SVD\_Transfer The TSF shall explicitly deny access of subjects to objects based on the following additional rules: none

### SCD\_Import SFP

- FDP\_ACF.1.1 /SCD\_Import The TSF shall enforce the SCD Import SFP to objects based on the following: General attribute group and Initialisation attribute group.
- FDP\_ACF.1.2 /SCD\_Import The TSF shall enforce the following rules to determine if an operation among controlled subjects and controlled objects is allowed: The user with the security attribute “role” set to “Administrator” or to “Signatory” and with the security attribute “SCD / SVD management” set to “authorized” is allowed to import SCD if the security attribute “secure SCD import allowed” is set to “yes”.
- FDP\_ACF.1.3 /SCD\_Import The TSF shall explicitly authorize access of subjects to objects based on the following additional rules: none.
- FDP\_ACF.1.4 /SCD\_Import The TSF shall explicitly deny access of subjects to objects based on the following additional rules:
- (a) The user with the security attribute “role” set to “Administrator” or to “Signatory” and with the security attribute “SCD / SVD management” set to “not authorized” is not allowed to import SCD if the security attribute “secure SCD import allowed” is set to “yes”.
  - (b) The user with the security attribute “role” set to “Administrator” or to “Signatory” and with the security attribute “SCD / SVD management” set to “authorized” is not allowed to import SCD if the security attribute “secure SCD import allowed” is set to “no”.

*Application note:* Type 2 only.

### Personalisation SFP

- FDP\_ACF.1.1 /Personalisation The TSF shall enforce the Personalisation SFP to objects based on the following: General attribute group
- FDP\_ACF.1.2 /Personalisation The TSF shall enforce the following rules to determine if an operation among controlled subjects and controlled objects is allowed: User with the security attribute “role” set to “Administrator” is allowed to create the RAD.

	Reference <b>D1371562</b>	Release <b>1.0p</b> (Printed copy not controlled: verify the version before using)
	Classification Level <b>Public</b>	Pages <b>61</b>

FDP\_ACF.1.3 /Personalisation The TSF shall explicitly authorize access of subjects to objects based on the following additional rules: none.

FDP\_ACF.1.4 /Personalisation The TSF shall explicitly deny access of subjects to objects based on the following additional rules: none.

### Signature\_Creation SFP

FDP\_ACF.1.1 /Signature\_Creation The TSF shall enforce the Signature Creation SFP to objects based on the following: General attribute group and Signature-creation attribute group

FDP\_ACF.1.2 /Signature\_Creation The TSF shall enforce the following rules to determine if an operation among controlled subjects and controlled objects is allowed:  
User with the security attribute "role" set to "Signatory" is allowed to create electronic signatures for DTBS sent by an authorized SCA with SCD by the Signatory which security attribute "SCD operational" is set to "yes".

FDP\_ACF.1.3 /Signature\_Creation The TSF shall explicitly authorize access of subjects to objects based on the following additional rules: none.

FDP\_ACF.1.4 /Signature\_Creation The TSF shall explicitly deny access of subjects to objects based on the following additional rules:

- (a) User with the security attribute "role" set to "Signatory" is not allowed to create electronic signatures for DTBS which is not sent by an authorized SCA with SCD by the Signatory which security attribute "SCD operational" is set to "yes".
- (b) User with the security attribute "role" set to "Signatory" is not allowed to create electronic signatures for DTBS sent by an authorized SCA with SCD by the Signatory which security attribute "SCD operational" is set to "no".

### FDP\_ETC.1 Export of user data without security attributes

Hierarchical to: No other components  
Dependencies: [FDP\_ACC.1 Subset access control, or FDP\_IFC.1 Subset information flow control]

FDP\_ETC.1.1 The TSF shall enforce the SVD transfer SFP when exporting user data, controlled under the SFP(s), outside of the TOE.

FDP\_ETC.1.2 The TSF shall export the user data without the user data's associated security attributes.

*Application note:*

	Reference <b>D1371562</b>	Release <b>1.0p</b> <small>(Printed copy not controlled: verify the version before using)</small>
	Classification Level <b>Public</b>	Pages <b>61</b>

FDP\_ETC.1/SVD Transfer SFP will be required only, if the TOE holds the SVD and the SVD is exported to the CGA for certification.

**FDP\_ITC.1/SCD Import of user data without security attributes**

Hierarchical to: No other components  
 Dependencies: [FDP\_ACC.1 Subset access control, or  
 FDP\_IFC.1 Subset information flow control]  
 FMT\_MSA.3 Static attribute initialization

- FDP\_ITC.1.1 /SCD      The TSF shall enforce the SCD Import SFP when importing user data, controlled under the SFP, from outside of the TOE.
- FDP\_ITC.1.2 /SCD      The TSF shall ignore any security attributes associated with the SCD when imported from outside the TOE.
- FDP\_ITC.1.3 /SCD      The TSF shall enforce the following rules when importing user data controlled under the SFP from outside the TOE: SCD shall be sent by an Authorized SSCD.

*Application note:*

A SSCD of Type 1 is authorised to send SCD to a SSCD of Type 2, if it is designated to generate the SCD for this SSCD of Type 2 and to export the SCD for import into this SSCD of Type 2. Authorised SSCD of Type 1 are able to establish a trusted channel to the SSCD of Type 2 for SCD transfer as required by FDP\_ITC.1.3/SCD export.

Type 2 only.

**FDP\_ITC.1/DTBS Import of user data without security attributes**

Hierarchical to: No other components  
 Dependencies: [FDP\_ACC.1 Subset access control, or  
 FDP\_IFC.1 Subset information flow control]  
 FMT\_MSA.3 Static attribute initialization

- FDP\_ITC.1.1 /DTBS      The TSF shall enforce the Signature Creation SFP when importing user data, controlled under the SFP, from outside of the TOE.
- FDP\_ITC.1.2 /DTBS      The TSF shall ignore any security attributes associated with the DTBS when imported from outside the TOE.
- FDP\_ITC.1.3 /DTBS      The TSF shall enforce the following rules when importing user data controlled under the SFP from outside the TOE: DTBS representation shall be sent by an Authorized SCA.

**FDP\_RIP.1 Subset residual information protection**

Hierarchical to: No other components

	Reference <b>D1371562</b>	Release <b>1.0p</b> (Printed copy not controlled: verify the version before using)
	Classification Level <b>Public</b>	Pages <b>61</b>

Dependencies:    No dependency

FDP\_RIP.1.1    The TSF shall ensure that any previous information content of a resource is made unavailable upon the de-allocation of the resource from the following objects: SCD, VAD, RAD.

The following data persistently stored by TOE have the user data attribute "integrity checked persistent stored data":

1. SCD
2. RAD
3. SVD (if persistent stored by TOE).

The DTBS/R temporarily stored by TOE has the user data attribute "integrity checked stored data":

#### **FDP\_SDI.2/Persistent Stored data integrity monitoring and action**

Hierarchical to:    FDP\_SDI.1  
Dependencies:    No dependency

FDP\_SDI.2.1    The TSF shall monitor user data stored in containers controlled by the TSF for integrity error /Persistent on all objects, based on the following attributes: integrity checked persistent stored data.

FDP\_SDI.2.2    Upon detection of a data integrity error, the TSF shall :  
/Persistent    1. prohibit the use of the altered data  
                    2. inform the Signatory about integrity error.

#### **DTBS-representation**

The DTBS representation temporarily stored by TOE has the user data attribute "integrity checked stored data"

#### **FDP\_SDI.2/DTBS Stored data integrity monitoring and action**

Hierarchical to:    FDP\_SDI.1  
Dependencies:    No dependency

FDP\_SDI.2.1    The TSF shall monitor user data stored in containers controlled by the TSF for integrity error /DTBS on all objects, based on the following attributes: integrity checked stored DTBS.

FDP\_SDI.2.2    Upon detection of a data integrity error, the TSF shall :  
/DTBS            1. prohibit the use of the altered data  
                    2. inform the Signatory about integrity error.

#### **FDP\_UCT.1 Basic data exchange confidentiality**

Hierarchical to:    No other components  
Dependencies:    [FDP\_ACC.1 Subset access control, or  
                         FDP\_IFC.1 Subset information flow control]  
                         [FTP\_ITC.1 Inter-TSF trusted channel, or  
                         FTP\_TRP.1 Trusted path]

FDP\_UCT.1.1    The TSF shall enforce the SCD Import SFP to be able to receive SCD in a manner

	Reference <b>D1371562</b>	Release <b>1.0p</b> <small>(Printed copy not controlled: verify the version before using)</small>
	Classification Level <b>Public</b>	Pages <b>61</b>

/SCD protected from unauthorized disclosure.

Application note: Type 2 only.

### FDP\_UIT.1 Data exchange integrity

Hierarchical to: No other components  
 Dependencies: [FDP\_ACC.1 Subset access control, or FDP\_IFC.1 Subset information flow control] [FTP\_ITC.1 Inter-TSF trusted channel, or FTP\_TRP.1 Trusted path]

FDP\_UIT.1.1 /SVD Transfer The TSF shall enforce the SVD Transfer SFP to be able to transmit user data in a manner protected from modification and insertion errors.

FDP\_UIT.1.2 /SVD Transfer The TSF shall be able to determine on receipt of user data, whether modification and insertion has occurred.

FDP\_UIT.1.1 /TOE DTBS The TSF shall enforce the Signature creation SFP to be able to receive the DTBS-representation in a manner protected from modification,deletion and insertion errors.

FDP\_UIT.1.2 / TOE DTBS The TSF shall be able to determine on receipt of user data, whether modification, deletion and insertion has occurred.

## 6.1.3 Class FIA Identification and Authentication

### FIA\_AFL.1/PERSO Authentication failure handling

Hierarchical to: No other components  
 Dependencies: FIA\_UAU.1 Timing of authentication

FIA\_AFL.1.1 /PERSO The TSF shall detect when [**Number in Table 10**] unsuccessful authentication attempts occurs related to consecutive failed **authentication attempts**.

FIA\_AFL.1.2 /PERSO When the defined number of unsuccessful authentication attempts has been met, the TSF shall block key.

Auth type	Number	Actions
<b>GP</b>	<b>3</b>	<b>Block GP authentication.</b>

**Table 10: FIA\_AFL.1/PERSO refinements**

	Reference <b>D1371562</b>	Release <b>1.0p</b> (Printed copy not controlled: verify the version before using)
	Classification Level <b>Public</b>	Pages <b>61</b>

### FIA\_AFL.1/SIG Authentication failure handling

Hierarchical to: No other components  
Dependencies: FIA\_UAU.1 Timing of authentication

FIA\_AFL.1.1 /SIG      The TSF shall detect when **[3]** unsuccessful authentication attempts occur related to consecutive failed authentication attempts.

FIA\_AFL.1.2 /SIG      When the defined number of unsuccessful authentication attempts has been met, the TSF shall block RAD.

Note: PIN or BioPIN could be used for user authentication.

### FIA\_ATD.1 User attribute definition

Hierarchical to: No other components  
Dependencies: No dependencies

FIA\_ATD.1.1      The TSF shall maintain the following list of security attributes belonging to individual users: RAD.

### FIA\_UAU.1/PERSO Timing of authentication

Hierarchical to: No other components  
Dependencies: FIA\_UID.1 Timing of identification

FIA\_UAU.1.1 /PERSO      The TSF shall allow  
1. Self test according to FPT\_TST.1.  
2. Identification of the user by means of TSF required by FIA\_UID.1.  
3. No other Signature generation related action.  
on behalf of the user to be performed before the user is authenticated.

FIA\_UAU.1.2 /PERSO      The TSF shall require each user to be successfully authenticated before allowing any other TSF-mediated actions on behalf of that user.

### FIA\_UAU.1/SIG Timing of authentication

Hierarchical to: No other components  
Dependencies: FIA\_UID.1 Timing of identification

FIA\_UAU.1.1 /SIG      The TSF shall allow  
**1 [Identification of the user by means of TSF required by FIA\_UID.1]**  
**2 [Establishing a trusted channel between the TOE and a SSCD of type 1 by means of TSF required by FTP\_ITC.1/SCD import]**  
**3 [Establishing a trusted path between local user and the TOE by means of TSF required by FTP\_TRP.1/TOE]**

	Reference <b>D1371562</b>	Release <b>1.0p</b> <small>(Printed copy not controlled: verify the version before using)</small>
	Classification Level <b>Public</b>	Pages <b>61</b>

**4 [Establishing a trusted channel between the SCA and the TOE by means of TSF required by FTP\_ITC.1/DTBS import]**

on behalf of the user to be performed before the user is authenticated.

FIA\_UAU.1.2 /SIG The TSF shall require each user to be successfully authenticated before allowing any other TSF-mediated actions on behalf of that user.

Application note:

The TSF shall allow no Signature generation related action to be performed before user is authenticated. That means that other actions, not specifically related to the Signature creation, may be performed before user is authenticated.

PIN or BioPIN could be used for user authentication.

**FIA\_UID.1/PERSO Timing of identification**

Hierarchical to: No other components

Dependencies: No dependencies

FIA\_UID.1.1 /PERSO The TSF shall allow  
 1. Self test according to FPT\_TST.1.  
 2. **No other Signature generation related action.**  
 on behalf of the user to be performed before the user is identified.

FIA\_UID.1.2 /PERSO The TSF shall require each user to be successfully identified before allowing any other TSF-mediated actions on behalf of that user.

**FIA\_UID.1/SIG Timing of identification**

Hierarchical to: No other components

Dependencies: No dependencies

FIA\_UID.1.1 /SIG The TSF shall allow  
 1. Establishing a trusted channel between the TOE and a SSCD of Type 1 by means of TSF required by FTP\_ITC.1/SCD import.  
 2. Establishing a trusted path between local user and the TOE by means of TSF required by FTP\_TRP.1/TOE.  
 3. Establishing a trusted channel between the SCA and the TOE by means of TSF required by FTP\_ITC.1/DTBS import.]  
 on behalf of the user to be performed before the user is identified

FIA\_UID.1.2 /SIG The TSF shall require each user to be successfully identified before allowing any other TSF-mediated actions on behalf of that user.

Note: PIN or BioPIN could be used for user authentication.



	Reference <b>D1371562</b>	Release <b>1.0p</b> <small>(Printed copy not controlled: verify the version before using)</small>
	Classification Level <b>Public</b>	Pages <b>61</b>

---

## 6.1.4 Class FMT Security Management

### FMT\_MOF.1 Management of security functions behaviour

Hierarchical to: No other components  
 Dependencies: FMT\_SMR.1 Security roles.  
 FMT\_SMF.1 Specification of Management functions

FMT\_MOF.1.1 The TSF shall restrict the ability to enable the signature-creation function to Signatory.

### FMT\_MSA.1/Signatory Management of security attributes

Hierarchical to: No other components  
 Dependencies: [FDP\_ACC.1 Subset access control, or  
 FDP\_IFC.1 Subset information flow control]  
 FMT\_SMR.1 Security roles  
 FMT\_SMF.1 Specification of Management functions

FMT\_MSA.1.1 The TSF shall enforce the Signature-creation SFP to restrict the ability to modify the /Signatory security attributes SCD operational to Signatory.

### FMT\_MSA.1/AdminKG Management of security attributes

Hierarchical to: No other components  
 Dependencies: [FDP\_ACC.1 Subset access control, or  
 FDP\_IFC.1 Subset information flow control]  
 FMT\_SMR.1 Security roles  
 FMT\_SMF.1 Specification of Management functions

FMT\_MSA.1.1 The TSF shall enforce the Initialisation SFP to restrict the ability to modify the security /AdminKG attributes SCD / SVD management to Administrator.

*Application note:*

The Initialisation SFP enforcing comes from Type 3

### FMT\_MSA.1/AdminKI Management of security attributes

Hierarchical to: No other components  
 Dependencies: [FDP\_ACC.1 Subset access control, or  
 FDP\_IFC.1 Subset information flow control]  
 FMT\_SMR.1 Security roles  
 FMT\_SMF.1 Specification of Management functions

FMT\_MSA.1.1 The TSF shall enforce the SCD Import SFP to restrict the ability to modify the security /AdminKI attributes SCD / SVD management to Administrator.

	Reference <b>D1371562</b>	Release <b>1.0p</b> <small>(Printed copy not controlled: verify the version before using)</small>
	Classification Level <b>Public</b>	Pages <b>61</b>

*Application note:*

The SCD Import SFP enforcing comes from Type 2.

**FMT\_MSA.2 Secure security attributes**

Hierarchical to: No other components  
 Dependencies: [FDP\_ACC.1 Subset access control, or  
 FDP\_IFC.1 Subset information flow control]  
 FMT\_MSA.1 Management of security attributes  
 FMT\_SMR.1 Security roles

FMT\_MSA.2.1 The TSF shall ensure that only secure values are accepted for SCD / SVD Management and SCD operational.

**FMT\_MSA.3/Keygen Static attribute initialization**

Hierarchical to: No other components  
 Dependencies: FMT\_MSA.1 Management of security attributes  
 FMT\_SMR.1 Security roles

FMT\_MSA.3.1 The TSF shall enforce the SCD/SVD\_Generation\_SFP, SVD\_Transfer\_SFP and Signature-creation\_SFP to provide restrictive default values for security attributes that are used to enforce the SFP.

FMT\_MSA.3.2 The TSF shall allow the Administrator to specify alternative initial values to override the default values when an object or information is created.

*Application note:* Type 3 only.

**FMT\_MSA.3/KeyImport Static attribute initialization**

Hierarchical to: No other components  
 Dependencies: FMT\_MSA.1 Management of security attributes  
 FMT\_SMR.1 Security roles

FMT\_MSA.3.1 The TSF shall enforce the SCD\_Import\_SFP and Signature-creation\_SFP to provide restrictive default values for security attributes that are used to enforce the SFP.

FMT\_MSA.3.2 The TSF shall allow the Administrator to specify alternative initial values to override the default values when an object or information is created.

	Reference <b>D1371562</b>	Release <b>1.0p</b> (Printed copy not controlled: verify the version before using)
	Classification Level <b>Public</b>	Pages <b>61</b>

Application note: Type 2 only.

#### **FMT\_MSA.4/Keygen Static attribute value inheritance**

Hierarchical to: No other components  
 Dependencies: [FDP\_ACC.1 Subset access control, or  
 FDP\_IFC.1 Subset information flow control]

- FMT\_MSA.4.1 /Keygen The TSF shall use the following rules to set the value of security attributes:
1. If S.Admin successfully generates an SCD/SVD pair without S.Sigy being authenticated the security attribute “SCD operational of the SCD” shall be set to “no” as a single operation.
  2. If S.Sigy successfully generates an SCD/SVD pair the security attribute “SCD operational of the SCD” shall be set to “yes” as a single operation.

#### **FMT\_MSA.4/KeyImport Static attribute value inheritance**

Hierarchical to: No other components  
 Dependencies: [FDP\_ACC.1 Subset access control, or  
 FDP\_IFC.1 Subset information flow control]

- FMT\_MSA.4.1 /KeyImport The TSF shall use the following rules to set the value of security attributes:
1. If S.Admin imports SCD without the S.Sigy being authenticated the same time the security attribute “SCD operational” of the SCD shall be set to “no” after import of the SCD as a single operation.
  2. If S.Admin imports SCD while the S.Sigy being authenticated the same time the security attribute “SCD operational” of the SCD shall be set to “yes” after import of the SCD as a single operation.

Application note:  
 FMT\_MSA.4/KeyGen and FMT\_MSA.4/KeyImport are not defined in the claimed PP [CWA-14168-2] and [CWA-14168-3]; they have been introduced in [EN-14168-2] and [EN-14168-3]. The ST writer has elected to introduce them in this ST as they provide additional information on security attributes.

#### **FMT\_MTD.1/Admin Management of TSF data**

Hierarchical to: No other components  
 Dependencies: FMT\_SMR.1 Security roles  
 FMT\_SMF.1 Specification of management functions

- FMT\_MTD.1.1 /Admin The TSF shall restrict the ability to create the RAD to Administrator.

#### **FMT\_MTD.1/Signatory Management of TSF data**

Hierarchical to: No other components  
 Dependencies: FMT\_SMR.1 Security roles

	Reference <b>D1371562</b>	Release <b>1.0p</b> (Printed copy not controlled: verify the version before using)
	Classification Level <b>Public</b>	Pages <b>61</b>

---

### FMT\_SMF.1 Specification of management functions

FMT\_MTD.1.1 The TSF shall restrict the ability to modify the RAD to Signatory.  
/Signatory

### FMT\_SMF.1 Specification of management functions

Hierarchical to: No other components  
Dependencies: No dependencies

FMT\_SMF.1.1 The TSF shall be capable of performing the following security management functions:

1. Creation and modification of RAD.
2. Enabling the signature-creation function.
3. Modification of the security attribute SCD/SVD management, SCD operational.
4. Change the default value of the security attribute SCD Identifier.
5. **No other security management function.**

### FMT\_SMR.1 Security roles

Hierarchical to: No other components  
Dependencies: FIA\_UID.1 Timing of identification

FMT\_SMR.1.1 The TSF shall maintain the roles Administrator and Signatory

FMT\_SMR.1.2 The TSF shall be able to associate users with roles.

## 6.1.5 Class FPT Protection of the Security Functions

### FPT\_EMS.1 TOE Emanation

Hierarchical to: No other components  
Dependencies: No dependencies

FPT\_EMS.1.1 The TOE shall not emit **[electromagnetic and current emissions]** in excess of **[intelligible threshold]** enabling access to RAD and SCD.

FPT\_EMS.1.2 The TSF shall ensure **[unauthorized users]** are unable to use the following interface: **smart card circuit contacts** to gain access to RAD and SCD.

	Reference <b>D1371562</b>	Release <b>1.0p</b> (Printed copy not controlled: verify the version before using)
	Classification Level <b>Public</b>	Pages <b>61</b>

### FPT\_FLS.1 Failure with preservation of secure state

Hierarchical to: No other components  
 Dependencies: No dependencies

FPT\_FLS.1.1 The TSF shall preserve a secure state when the following types of failures occur:

1. self-test according to FPT\_TST fails.
2. **[No other failure].**

### FPT\_PHP.1 Passive detection of physical attack

Hierarchical to: No other components  
 Dependencies: No dependencies

FPT\_PHP.1.1 The TSF shall provide unambiguous detection of physical tampering that might compromise the TSF.

FPT\_PHP.1.2 The TSF shall provide the capability to determine whether physical tampering with the TSF's devices or TSF's elements has occurred.

### FPT\_PHP.3 Resistance to physical attack

Hierarchical to: No other components  
 Dependencies: No dependencies

FPT\_PHP.3.1 The TSF shall resist **[clock frequency, voltage tampering and penetration of protection layer]** to the **[integrated circuit]** by responding automatically such that the SFRs are always enforced.

### FPT\_TST.1 TSF testing

Hierarchical to: No other components  
 Dependencies: No dependencies

FPT\_TST.1.1 The TSF shall run a suite of self tests **[see Table 11: conditions triggering tests]** to demonstrate the correct operation of the TSF.

FPT\_TST.1.2 The TSF shall provide authorized users with the capability to verify the integrity of TSF data.

FPT\_TST.1.3 The TSF shall provide authorized users with the capability to verify the integrity of TSF.

Conditions under which self test should occur	Description of the self test
<b>During initial start-up</b>	RNG live test, sensor test, FA detection, Integrity Check of NVM ES

	Reference <b>D1371562</b>	Release <b>1.0p</b> (Printed copy not controlled: verify the version before using)
	Classification Level <b>Public</b>	Pages <b>61</b>

<b>Periodically</b>	RNG monitoring, sensor test, FA detection
<b>After cryptographic computation</b>	FA detection
<b>Before any use or update of TSF data</b>	FA detection, Integrity Check of related TSF data

**Table 11: conditions triggering tests**

## 6.1.6 Class FTP Trusted Path/Channel

### FTP\_ITC.1/SCD import Inter-TSF trusted Channel

Hierarchical to: No other components

Dependencies: No dependencies

FTP\_ITC.1.1 /SCD import The TSF shall provide a communication channel between itself and a remote trusted IT product that is logically distinct from other communication channels and provides assured identification of its end points and protection of the channel data from modification or disclosure.

FTP\_ITC.1.2 /SCD import The TSF shall permit the remote trusted IT product to initiate communication via the trusted channel.

FTP\_ITC.1.3 /SCD import The TSF shall initiate communication via the trusted channel for

1. Data exchange integrity according to FDP\_UCT.1/SCD.
2. **[None].**

Application note:

The mentioned "remote trusted IT product" in FTP\_ITC.1/SCD import is an SSCD of type 1.

Application note:

The SCD Import must be protected in Integrity. This protection must be ensured by crypto mechanisms in the TOE. No "Trusted Environment" can ensure this integrity.

Type 2 only.

### FTP\_ITC.1/SVD transfer Inter-TSF trusted Channel

Hierarchical to: No other components

Dependencies: No dependencies

FTP\_ITC.1.1 /SVD transfer The TSF shall provide a communication channel between itself and a remote trusted IT product CGA that is logically distinct from other communication channels and provides assured identification of its end points and protection of the channel data from modification or disclosure.

FTP\_ITC.1.2 / SVD transfer The TSF shall permit the remote trusted IT product to initiate communication via the trusted channel.

FTP\_ITC.1.3 / SVD transfer The TSF or the CGA shall initiate communication via the trusted channel for SVD transfer.

	Reference <b>D1371562</b>	Release <b>1.0p</b> <small>(Printed copy not controlled: verify the version before using)</small>
	Classification Level <b>Public</b>	Pages <b>61</b>

Application note:

The mentioned "remote trusted IT product" in FTP\_ITC.1/SVD transfer is a CGA.

Application note:

The SVD Transfer must be protected in Integrity. This protection can be ensured by crypto mechanisms in the TOE. It can also be ensured by a "Trusted Environment". At personalization time, the Issuer will be able to assess if the usage environment will be a "Trusted Environment".

**FTP\_ITC.1/DTBS import Inter-TSF trusted Channel**

Hierarchical to: No other components

Dependencies: No dependencies

FTP\_ITC.1.1 /DTBS import      The TSF shall provide a communication channel between itself and another trusted IT product that is logically distinct from other communication channels and provides assured identification of its end points and protection of the channel data from modification or disclosure.

FTP\_ITC.1.2 /DTBS import      The TSF shall permit the SCA to initiate communication via the trusted channel.

FTP\_ITC.1.3 /DTBS import      The TSF or the SCA shall initiate communication via the trusted channel for signing DTBS-representation.

Application note:

The mentioned "another trusted IT product" in FTP\_ITC.1/DTBS import is an SCA.

Application note:

The DTBS Import must be protected in Integrity. This protection can be ensured by crypto mechanisms in the TOE. It can also be ensured by a "Trusted Environment". At personalization time, the Issuer will be able to assess if the usage environment will be a "Trusted Environment".

**FTP\_TRP.1/TOE Trusted Path**

Hierarchical to: No other components

Dependencies: No dependencies

FTP\_TRP.1.1 /TOE      The TSF shall provide a communication path between itself and local users that is logically distinct from other communication paths and provides assured identification of its end points and protection of the communicated data from modification or disclosure..

FTP\_TRP.1.2 / TOE      The TSF shall permit local users to initiate communication via the trusted path.

FTP\_TRP.1.3 / TOE      The TSF shall require the use of the trusted path for initial user authentication.

Application note:

	Reference <b>D1371562</b>	Release <b>1.0p</b> <small>(Printed copy not controlled: verify the version before using)</small>
	Classification Level <b>Public</b>	Pages <b>61</b>

---

The RAD/VAD Import must be protected in Integrity and confidentiality. This protection can be ensured by crypto mechanisms in the TOE. It can also be ensured by a “Trusted Environment”. At personalization time, the Issuer will be able to assess if the usage environment will be a “Trusted Environment”.

## 6.2 SECURITY ASSURANCE REQUIREMENTS FOR THE TOE

The SAR for the evaluation of the TOE and its development and operating environment are those taken from the Evaluation Assurance Level 5 (EAL5) and augmented by taking the following components: ALC\_DVS.2, and AVA\_VAN.5.



	Reference <b>D1371562</b>	Release <b>1.0p</b> (Printed copy not controlled: verify the version before using)
	Classification Level <b>Public</b>	Pages <b>61</b>

## 6.3 SECURITY REQUIREMENTS RATIONALE

### 6.3.1 SFR and PP

Requirements	[CWA-14169-3]	[CWA-14169-2]	[EN-14169-2]	[EN-14169-3]	additions
FCS_CKM.1/SCD	X		X		
FCS_CKM.1/Session					X
FCS_CKM.4/SCD	X	X	X	X	
FCS_CKM.4/Session					X
FCS_COP.1/CORRESP	X	X			
FCS_COP.1/DSC	X	X	X	X	
FCS_COP.1/Session					X
FDP_ACC.1/Signature-creation SFP	X	X	X	X	
FDP_ACF.1/Signature-creation SFP	X	X	X	X	
FDP_ACC.1/Initialisation SFP	X		X		
FDP_ACF.1/Initialisation SFP	X		X		
FDP_ACC.1/SVD transfer SFP	X	X	X		
FDP_ACF.1/SVD transfer SFP	X	X	X		
FDP_ACC.1/SCD import SFP		X		X	
FDP_ACF.1/SCD import SFP		X		X	
FDP_ACC.1/Personalisation SFP	X	X			
FDP_ACF.1/Personalisation SFP	X	X			
FDP_ETC.1	X	X			
FDP_ITC.1/SCD		X		X	
FDP_ITC.1/DTBS	X	X			
FDP_RIP.1	X	X	X	X	
FDP_SDI.2/Persistent	X	X	X	X	
FDP_SDI.2/DTBS	X	X	X	X	
FDP_UCT.1/SCD		X		X	
FDP_UIT.1/SVD Transfer	X	X			
FDP_UIT.1/TOE DTBS	X	X			
FIA_AFL.1/PERSO					X
FIA_AFL.1/SIG	X	X	X	X	
FIA_ATD.1	X	X			
FIA_UAU.1/PERSO					X
FIA_UAU.1/SIG	X	X	X	X	
FIA_UID.1/PERSO					X
FIA_UID.1/SIG	X	X	X	X	
FMT_MOF.1	X	X	X	X	
FMT_MSA.1/Signatory	X	X	X	X	

	Reference <b>D1371562</b>	Release <b>1.0p</b> <small>(Printed copy not controlled: verify the version before using)</small>
	Classification Level <b>Public</b>	Pages <b>61</b>

Requirements	[CWA-14169-3]	[CWA-14169-2]	[EN-14169-2]	[EN-14169-3]	additions
FMT_MSA.1/AdminKG	X		X		
FMT_MSA.1/AdminKI		X		X	
FMT_MSA.2	X	X	X	X	
FMT_MSA.3/Keygen	X		X		
FMT_MSA.3/KeyImport		X		X	
FMT_MSA.4/Keygen			X		
FMT_MSA.4/KeyImport				X	
FMT_MTD.1/Admin	X	X	X	X	
FMT_MTD.1/Signatory	X	X	X	X	
FMT_SMF.1	X		X	X	
FMT_SMR.1	X	X	X	X	
FPT_EMS.1	X	X	X	X	
FPT_FLS.1	X	X	X	X	
FPT_PHP.1	X	X	X	X	
FPT_PHP.3	X	X	X	X	
FPT_TST.1	X	X	X	X	
FTP_ITC.1/SCD Import		X		X	
FTP_ITC.1/SVD Transfer	X	X			
FTP_ITC.1/DTBS Import	X	X			
FTP_TRP.1/TOE	X	X			

**Table 12: Objective vs SFR rationale**

### 6.3.2 Security Functional Requirements Rationale

#### 6.3.2.1 Security objectives for the TOE

Requirements	OT.EMSEC_Design	OT.Lifecycle_Security	OT.SCD_Secrecy	OT.SCD_SVD_Corresp	OT.SVD_Auth_TOE	OT.Tamper_ID	OT.Tamper_Resistance	OT.DTBS_Integrity_TOE	OT.Sigy_SigF	OT.Sig_Secure	OT.SCD_Transfer (Type 2 only)	OT.SCD_Unique (Type 3 only)	OT.Init (Type 3 only)	OT.Init (Extensions)	OT_Pre-Personalisation
FCS_CKM.1/SCD			X	X								X			



Reference **D1371562**

Release **1.0p**  
(Printed copy not controlled: verify the version before using)

Classification Level **Public**

Pages **61**

FCS_CKM.1/Session				X			X			X				
FCS_CKM.4/SCD		X	X							X				
FCS_CKM.4/Session				X			X			X				
FCS_COP.1/CORRESP				X										
FCS_COP.1/DSC										X				
FCS_COP.1/Session			X	X			X			X				
FDP_ACC.1/Initialization SFP			X									X		
FDP_ACC.1/SVD transfer SFP				X										
FDP_ACC.1/SCD import SFP										X				
FDP_ACC.1/Personalisation SFP								X						
FDP_ACC.1/Signature-creation SFP							X	X						
FDP_ACF.1/Initialisation SFP			X									X		
FDP_ACF.1/SVD transfer SFP				X										
FDP_ACF.1/SCD import SFP										X				
FDP_ACF.1/Personalisation SFP								X						
FDP_ACF.1/Signature-creation SFP							X	X						
FDP_ETC.1				X										
FDP_ITC.1/SCD										X				
FDP_ITC.1/DTBS							X							
FDP_RIP.1			X					X						
FDP_SDI.2/Persistent			X	X				X	X					
FDP_SDI.2/DTBS							X							
FDP_UCT.1/SCD										X				
FDP_UIT.1/SVD Transfer				X										
FDP_UIT.1/TOE DTBS							X							
FIA_AFL.1/PERSO														X
FIA_AFL.1/SIG								X				X		
FIA_ATD.1								X				X		
FIA_UAU.1/PERSO														X
FIA_UAU.1/SIG								X				X		
FIA_UID.1/PERSO														X
FIA_UID.1/SIG								X				X		
FMT_MOF.1			X					X						
FMT_MSA.1/AdminKG			X									X		
FMT_MSA.1/AdminKI			X											
FMT_MSA.1/Signatory								X						
FMT_MSA.2								X	X					
FMT_MSA.3/Keygen			X					X	X					
FMT_MSA.3/KeyImport			X					X				X		
FMT_MSA.4/Keygen			X					X	X					
FMT_MSA.4/KeyImport			X					X				X		
FMT_MTD.1/Admin								X						
FMT_MTD.1/Signatory								X						
FMT_SMF.1			X					X						
FMT_SMR.1			X					X	X					

	Reference <b>D1371562</b>	Release <b>1.0p</b> <small>(Printed copy not controlled: verify the version before using)</small>
	Classification Level <b>Public</b>	Pages <b>61</b>

FPT_EMS.1	X																		
FPT_FLS.1			X																
FPT_PHP.1						X													
FPT_PHP.3							X												
FPT_TST.1		X									X								
FTP_ITC.1/SCD Import												X							
FTP_ITC.1/SVD Transfer						X													
FTP_ITC.1/DTBS Import										X									
FTP_TRP.1/TOE											X								

**Table 13: Objective vs SFR rationale**

**OT.EMSEC\_Design** (Provide physical emanations security) covers that no intelligible information is emanated. This is provided by *FPT\_EMS.1*.

**OT.Lifecycle\_Security** The test function *FPT\_TST.1* provides failure detection throughout the lifecycle. *FCS\_CKM.4/SCD* provides secure destruction of the SCD to conclude the operational usage of the TOE as SSCD.

**OT.SCD\_Secrecy** (Secrecy of signature-creation data) counters that, with reference to recital (18) of the Directive, storage or copying of SCD causes a threat to the legal validity of electronic signatures. The authentication and access management functions specified by *FMT\_MOF.1*, *FMT\_MSA.1/AdminKG*, *FMT\_MSA.1/AdminKI*, *FMT\_MSA.3*, *FMT\_MSA.4*, and *FMT\_SMR.1* ensure that only the signatory can use the SCD and thus avoid that an attacker may gain information on it. *OT.SCD\_Secrecy* is provided [for a Type 3 SSCD] by the security functions specified by *FDP\_ACC.1/Initialisation SFP* and *FDP\_ACF.1/Initialisation SFP* that ensure that only authorised user can initialise the TOE and create or load the SCD.

*FCS\_CKM.1/SCD* ensures the generation of SCD on board.

The security functions specified by *FDP\_RIP.1* and *FCS\_CKM.4/SCD* ensure that residual information on SCD is destroyed after the SCD has been used for signature creation and that destruction of SCD leaves no residual information. Cryptographic quality of SCD/SVD pair shall prevent disclosure of SCD by cryptographic attacks using the publicly known SVD.

The security functions specified by *FDP\_SDI.2/Persistent* ensure that no critical data is modified which could alter the efficiency of the security functions or leak information of the SCD. *FPT\_FLS.1* tests the working conditions of the TOE and guarantees a secure state when integrity is violated and thus assures that the specified security functions are operational. An example where compromising error conditions are countered by *FPT\_FLS* is differential fault analysis (DFA).

**OT.SCD\_SVD\_Corresp** (Correspondence between SVD and SCD) addresses that the SVD corresponds to the SCD implemented by the TOE. The security functions specified by *FDP\_SDI.2/Persistent* ensure that the keys are not modified, so to retain the correspondence. Cryptographic correspondence is provided by *FCS\_COP.1/CORRESP*. Additionally, for a Type 3 SSCD: This is provided by the algorithms specified by *FCS\_CKM.1/SCD* to generate corresponding SVD/SCD pairs.

**OT.SVD\_Auth\_TOE** (TOE ensures authenticity of the SVD) is provided by a trusted channel guaranteeing SVD origin and integrity by means of *FTP\_ITC.1/SVD Transfer* and *FDP\_UIT.1/SVD Transfer*. The cryptographic algorithms specified by *FDP\_ACC.1/SVD Transfer SFP* and *FDP\_ACF.1/SVD Transfer SFP* ensure that only authorised user can Import the SVD from a SSCD Type1 and Export the SVD to the CGA.

*FCS\_CKM.1/Session* ensures the generation of session keys. *FCS\_CKM.4/Session* ensures their destruction. *FCS\_COP.1/Session* ensures the integrity of data transmitted through the secure channel.

	Reference <b>D1371562</b>	Release <b>1.0p</b> (Printed copy not controlled: verify the version before using)
	Classification Level <b>Public</b>	Pages <b>61</b>

**OT.Tamper\_ID** (Tamper detection) is provided by *FPT\_PHP.1* by the means of passive detection of physical attacks.

**OT.Tamper\_Resistance** (Tamper resistance) is provided by *FPT\_PHP.3* to resist physical attacks.

**OT.DTBS\_Integrity\_TOE** (Verification of DTBS-representation integrity) covers that integrity of the DTBS-representation to be signed is to be verified, as well as the DTBS-representation is not altered by the TOE. This is provided by the trusted channel integrity verification mechanisms of *FDP\_ITC.1/DTBS*, *FTP\_ITC.1/DTBS Import* and by *FDP\_UIT.1/TOE DTBS*. The verification that the DTBS-representation has not been altered by the TOE is done by integrity functions specified by *FDP\_SDI.2/DTBS*. The access control requirements of *FDP\_ACC.1/Signature-creation SFP* and *FDP\_ACF.1/Signature-creation SFP* keeps unauthorised parties off from altering the DTBS-representation.

*FCS\_CKM.1/Session* ensures the generation of session keys. *FCS\_CKM.4/Session* ensures their destruction. *FCS\_COP.1/Session* ensures the integrity of DTBS transmitted through the secure channel.

**OT.Sigy\_SigF** (Signature generation function for the legitimate signatory only) is provided by *FIA\_UAU.1* and *FIA\_UID.1* that ensure that no signature generation function can be invoked before the signatory is identified and authenticated.

The security functions specified by *FDP\_ACC.1/Personalisation SFP*, *FDP\_ACC.1/Signature-creation SFP*, *FDP\_ACF.1/Personalisation SFP*, *FDP\_ACF.1/Signature-creation SFP*, *FMT\_MTD.1* and *FMT\_SMR.1* ensure that the signature process is restricted to the signatory.

The security functions specified by *FIA\_ATD.1*, *FMT\_MOF.1*, *FMT\_MSA.2*, *FMT\_MSA.3*, and *FMT\_MSA.4* ensure that the access to the signature generation functions remain under the sole control of the signatory, as well as *FMT\_MSA.1/Signatory* provides that the control of corresponding security attributes is under signatory's control.

The security functions specified by *FDP\_SDI.2/Persistent* and *FPT\_TRP.1/TOE* ensure the integrity of stored data both during communication and while stored.

The security functions specified by *FDP\_RIP.1* and *FIA\_AFL.1* provide protection against a number of attacks, such as cryptographic extraction of residual information, or brute force attacks against authentication.

**OT.Sig\_Secure** (Cryptographic security of the electronic signature) is provided by the cryptographic algorithms specified by *FCS\_COP.1/DSC* which ensures the cryptographic robustness of the signature algorithms. The security function specified by *FPT\_TST.1* ensures that the security functions are performing correctly. *FDP\_SDI.2/Persistent* corresponds to the integrity of the SCD implemented by the TOE.

### SSCD Type 2 only

**OT.SCD\_Transfer** (Secure transfer of SCD between SSCD) is provided by *FDP\_ITC.1/SCD Import* and *FDP\_UCT.1/Receiver* that ensure that a trusted channel is provided and that confidentiality is maintained.

Security functions specified by *FDP\_ACC.1/SCD Import SFP*, *FMT\_MSA.2*, *FMT\_MSA.3/KeyImport*, *FMT\_SMR.1* and *FDP\_ACF.1/SCD Import SFP* ensure that transfer of SCDs is restricted to administrators. This supports the confidentiality-oriented functions.

Security function *FCS\_CKM.4/SCD* destroys the SCD before a SCD is re-imported into the TOE.

*FCS\_CKM.1/Session* ensures the generation of session keys. *FCS\_CKM.4/Session* ensures their destruction. *FCS\_COP.1/Session* ensures the integrity of DTBS transmitted through the secure channel.

### SSCD Type 3 only

	Reference <b>D1371562</b>	Release <b>1.0p</b> <small>(Printed copy not controlled: verify the version before using)</small>
	Classification Level <b>Public</b>	Pages <b>61</b>

**OT.SCD\_Unique** (Uniqueness of the signature-creation data) stores the requirement of practically unique SCD as laid down in the Directive [1], Annex III, article 1(a), which is provided by the cryptographic algorithms specified by *FCS\_CKM.1/SCD*.

**OT.Init** It addresses that generation of a SCD/SVD pair requires proper user authentication. *FIA\_ATD.1* defines RAD as the corresponding user attribute. The TSF specified by *FIA\_UID.1* and *FIA\_UAU.1* provide user identification and user authentication prior to enabling access to authorised functions. The attributes of the authenticated user are provided by *FMT\_MSA.1/AdminKG*, *FMT\_MSA.1/AdminKI*, *FMT\_MSA.3/KeyGen*, and *FMT\_MSA.3/KeyImport*, for static attribute initialisation, and *FMT\_MSA.4/KeyGen*, and *FMT\_MSA.4/KeyImport*, for value inheritance. Access control is provided by *FDP\_ACC.1/Initialisation SFP* and *FDP\_ACF.1/Initialisation SFP*. Effort to bypass the access control by a frontal exhaustive attack is blocked by *FIA\_AFL.1*.

### Extensions

**OT.Pre-personalisation** (*strong authentication in Pre-personalisation*) is provided by the security functions specified by the following SFR. *FIA\_AFL.1/PERSO*, *FIA\_UAU.1/PERSO*, and *FIA\_UID.1/PERSO*

### 6.3.2.2 Dependency Rationale

Requirements	CC Dependencies	Satisfied Dependencies
FCS_CKM.1/SCD	(FCS_CKM.2 or FCS_COP.1) and (FCS_CKM.4)	FCS_COP.1/DSC, FCS_CKM.4/SCD
FCS_CKM.1/Session	(FCS_CKM.2 or FCS_COP.1) and (FCS_CKM.4)	FCS_COP.1/Session, FCS_CKM.4/Session
FCS_CKM.4/SCD	(FCS_CKM.1 or FDP_ITC.1 or FDP_ITC.2)	FCS_CKM.1/SCD, FDP_ITC.1/SCD,
FCS_CKM.4/Session	(FCS_CKM.1 or FDP_ITC.1 or FDP_ITC.2)	FCS_CKM.1/Session
FCS_COP.1/CORRESP	(FCS_CKM.1 or FDP_ITC.1 or FDP_ITC.2) and (FCS_CKM.4)	FCS_CKM.1/SCD, FDP_ITC.1/SCD, FCS_CKM.4/SCD,
FCS_COP.1/DSC	(FCS_CKM.1 or FDP_ITC.1 or FDP_ITC.2) and (FCS_CKM.4)	FCS_CKM.1/SCD, FCS_CKM.4/SCD, FDP_ITC.1/SCD,
FCS_COP.1/Session	(FCS_CKM.1 or FDP_ITC.1 or FDP_ITC.2) and (FCS_CKM.4)	FCS_CKM.1/Session, FCS_CKM.4/Session, FDP_ITC.1/SCD,
FDP_ACC.1/Initialization SFP	(FDP_ACF.1)	FDP_ACF.1/Initialization SFP
FDP_ACC.1/SVD transfer SFP	(FDP_ACF.1)	FDP_ACF.1/SVD transfer SFP
FDP_ACC.1/SCD import SFP	(FDP_ACF.1)	FDP_ACF.1/SCD import SFP
FDP_ACC.1/Personalization SFP	(FDP_ACF.1)	FDP_ACF.1/Personalization SFP
FDP_ACC.1/Signature-creation SFP	(FDP_ACF.1)	FDP_ACF.1/Signature-creation SFP
FDP_ACF.1/Initialization SFP	(FDP_ACC.1) and (FMT_MSA.3)	FDP_ACC.1/Initialization SFP, FMT_MSA.3/KeyImport, FMT_MSA.3/KeyGen
FDP_ACF.1/SVD transfer SFP	(FDP_ACC.1) and (FMT_MSA.3)	FDP_ACC.1/SVD transfer SFP, FMT_MSA.3/KeyGen
FDP_ACF.1/SCD import SFP	(FDP_ACC.1) and (FMT_MSA.3)	FDP_ACC.1/SCD import SFP, FMT_MSA.3/KeyImport
FDP_ACF.1/Personalization SFP	(FDP_ACC.1) and (FMT_MSA.3)	FDP_ACC.1/Personalization SFP, FMT_MSA.3/KeyImport,



Reference **D1371562**

Release **1.0p**  
 (Printed copy not controlled: verify the version before using)

Classification Level **Public**

Pages **61**

Requirements	CC Dependencies	Satisfied Dependencies
		FMT_MSA.3/KeyGen
FDP_ACF.1/Signature-creation SFP	(FDP_ACC.1) and (FMT_MSA.3)	FDP_ACC.1/Signature-creation SFP, FMT_MSA.3/KeyImport, FMT_MSA.3/KeyGen
FDP_ETC.1	(FDP_ACC.1 or FDP_IFC.1)	FDP_ACC.1/SVD transfer SFP
FDP_ITC.1/SCD	(FDP_ACC.1 or FDP_IFC.1) and (FMT_MSA.3)	FDP_ACC.1/SCD import SFP, FMT_MSA.3/KeyImport
FDP_ITC.1/DTBS	(FDP_ACC.1 or FDP_IFC.1) and (FMT_MSA.3)	FDP_ACC.1/Signature-creation SFP, FMT_MSA.3/KeyImport, FMT_MSA.3/KeyGen
FDP_RIP.1	No dependencies	
FDP_SDI.2/Persistent	No dependencies	
FDP_SDI.2/DTBS	No dependencies	
FDP_UCT.1/SCD	(FTP_ITC.1 or FTP_TRP.1) (FDP_ACC.1 or FDP_IFC.1)	FTP_ITC.1/SCD Import, FDP_ACC.1/SCD import SFP,
FDP_UIT.1/SVD Transfer	(FTP_ITC.1 or FTP_TRP.1) (FDP_ACC.1 or FDP_IFC.1)	FTP_ITC.1/SVD Transfer , FDP_ACC.1/SVD transfer SFP,
FDP_UIT.1/TOE DTBS	(FTP_ITC.1 or FTP_TRP.1) (FDP_ACC.1 or FDP_IFC.1)	FTP_ITC.1/DTBS import, FDP_ACC.1/Signature-creation,
FIA_AFL.1/PERSO	(FIA_UAU.1)	FIA_UAU.1/PERSO
FIA_AFL.1/SIG	(FIA_UAU.1)	FIA_UAU.1/SIG
FIA_ATD.1	No dependencies	
FIA_UAU.1/PERSO	(FIA_UID.1)	FIA_UID.1/PERSO
FIA_UAU.1/SIG	(FIA_UID.1)	FIA_UID.1/SIG
FIA_UID.1/PERSO	No dependencies	
FIA_UID.1	No dependencies	
FMT_MOF.1	(FMT_SMF.1) and (FMT_SMR.1)	FMT_SMR.1, FMT_SMF.1
FMT_MSA.1/AdminKG	(FDP_ACC.1 or FDP_IFC.1) and (FMT_SMF.1) and (FMT_SMR.1)	FDP_ACC.1/Initialization SFP, FMT_SMR.1, FMT_SMF.1
FMT_MSA.1/AdminKI	(FDP_ACC.1 or FDP_IFC.1) and (FMT_SMF.1) and (FMT_SMR.1)	FDP_ACC.1/SCD Import SFP, FMT_SMR.1, FMT_SMF.1
FMT_MSA.1/Signatory	(FDP_ACC.1 or FDP_IFC.1) and (FMT_SMF.1) and (FMT_SMR.1)	FDP_ACC.1/Signature-creation SFP, FMT_SMR.1, FMT_SMF.1
FMT_MSA.2	(FDP_ACC.1 or FDP_IFC.1) and (FMT_MSA.1) and (FMT_SMR.1)	FDP_ACC.1/Personalisation SFP, FMT_MSA.1/AdminKG, FMT_MSA.1/AdminKI, FMT_MSA.1/Signatory, FMT_SMR.1
FMT_MSA.3/KeyImport	(FMT_MSA.1) and (FMT_SMR.1)	FMT_MSA.1/AdminKI, FMT_MSA.1/Signatory, FMT_SMR.1
FMT_MSA.3/KeyGen	(FMT_MSA.1) and (FMT_SMR.1)	FMT_MSA.1/AdminKG, FMT_MSA.1/Signatory, FMT_SMR.1
FMT_MSA.4/KeyImport	FDP_ACC.1 or FDP_IFC.1	FDP_ACC.1/SCD Import SFP FDP_ACC.1/Signature-creation SFP
FMT_MSA.4/KeyGen	FDP_ACC.1 or FDP_IFC.1	FDP_ACC.1/Initialization SFP FDP_ACC.1/Signature-creation SFP
FMT_MTD.1/Admin	(FMT_SMF.1) and (FMT_SMR.1)	FMT_SMR.1,



	Reference <b>D1371562</b>	Release <b>1.0p</b> (Printed copy not controlled: verify the version before using)
	Classification Level <b>Public</b>	Pages <b>61</b>

Requirements	CC Dependencies	Satisfied Dependencies
		FMT_SMF.1
FMT_MTD.1/Signatory	(FMT_SMF.1) and (FMT_SMR.1)	FMT_SMR.1, FMT_SMF.1
FMT_SMF.1	No dependencies	
FMT_SMR.1	(FIA_UID.1)	FIA_UID.1
FPT_EMS.1	No dependencies	
FPT_FLS.1	No dependencies	
FPT_PHP.1	No dependencies	
FPT_PHP.3	No dependencies	
FPT_TST.1	No dependencies	
FTP_ITC.1/SCD Import	No dependencies	
FTP_ITC.1/SVD Transfer	No dependencies	
FTP_ITC.1/DTBS Import	No dependencies	
FTP_TRP.1/TOE	No dependencies	

**Table 14: Dependency rationale**

**Note:**

The SHA-1 algorithm uses no key. Therefore, the dependency from FCS\_COP.1/HASH to FCS\_CKM.1 for generation of keys or FDP\_ITC.1 or FDP\_ITC.2 for import of keys and FCS\_CKM.4 is not fulfilled.

### 6.3.3 Security Assurance Requirements Rationale

EAL5 was chosen because it provides a high level of independently assured security in a planned development. It requires a rigorous development approach without incurring unreasonable costs attributable to specialist security engineering techniques.

The selection of the component ALC\_DVS.2 provides a higher assurance of the security of the SSCD's development and manufacturing especially for the secure handling of the SSCD's material.

The selection of the component AVA\_VAN.5 provides a higher assurance of the security by vulnerability analysis to assess the resistance to penetration attacks performed by an attacker possessing a high attack potential.

### 6.3.4 Compatibility between SFR of [ST-IAS] and [ST-PLTF]

FCS\_CKM.1 and FCS\_COP.1 of [ST-IAS] are supported by FCS\_CKM.1 and FCS\_COP.1 of [ST-PLTF].

FDP\_SDI.2 of [ST-IAS] is supported by FDP\_SDI.2 of [ST-PLTF].

FPT\_PHP.3 of [ST-IAS] is supported by FPT\_PHP.3 of [ST-PLTF].

FPT\_EMS.1, FPT\_FLS.1, FPT\_TST.1, FPT\_PHP.1 and FPT\_PHP.3 of [ST-IAS] are supported by FPT\_TST.1 of [ST-PLTF].

FCS\_CKM.4, FDP\_ACC.1, FDP\_ACF.1, FDP\_ETC.1, FDP\_ITC.1, FDP\_RIP.1, FDP\_UCT.1, FDP\_UIT.1, FIA\_AFL.1, FIA\_ATD.1, FIA\_UAU.1, FIA\_UID.1, FMT\_MOF.1, FMT\_MSA.1, FMT\_MSA.2, FMT\_MSA.3, FMT\_MTD.1, FMT\_SMF.1, FMT\_SMR.1, FPT\_EMS.1, FTP\_ITC.1, and FTP\_TRP.1 are SFR specific to the IAS application and they do no conflict with the SFR of [ST-PLTF].

We can therefore conclude that the SFR of [ST-IAS] and [ST-PLTF] are consistent.



	Reference <b>D1371562</b>	Release <b>1.0p</b> <small>(Printed copy not controlled: verify the version before using)</small>
	Classification Level <b>Public</b>	Pages <b>61</b>

---

	Reference <b>D1371562</b>	Release <b>1.0p</b> (Printed copy not controlled: verify the version before using)
	Classification Level <b>Public</b>	Pages <b>61</b>

## 7. TOE SUMMARY SPECIFICATION

### 7.1 TOE SECURITY FUNCTIONS

TOE Security Functions are provided by the IAS applet and by the chip.  
The security functions provided by the platform are described in [ST-PLTF].

#### 7.1.1 SF provided by IAS Applet

This section presents the security functions provided by the IAS applet.

Identification	Name
SF.AUTHENTICATION	Authentication management
SF.CRYPTO	Cryptography management
SF.INTEGRITY	Integrity monitoring
SF.MANAGEMENT	Operation management and access control
SF.SECURE_MESSAGING	Secure messaging management
SF.CSM	Card Security Management

*Table 15: TOE security functions list*

SF.AUTHENTICATION provides the authentication management on the TOE. It encompasses:

- The identification and authentication in personalisation phase as defined in :
  - FIA\_AFL.1/PERSO , FIA\_UAU.1/PERSO and FIA\_UID.1/PERSO
- The identification and authentication in operational phase as defined in :
  - FIA\_ATD.1,FIA\_AFL.1/SIG , FIA\_UAU.1/SIG and FIA\_UID.1/SIG

Note: PIN or BioPIN could be used for user authentication.

SF.CRYPTO provides the crypto management on the TOE. It encompasses:

- The generation of SCD/SVD and session keys as defined in **FCS\_CKM.1/SCD**, **FCS\_COP.1/CORRESP** and **FCS\_CKM.1/Session**,
- The destruction of SCD and session keys as defined in **FCS\_CKM.4/SCD** and **FCS\_CKM.4/Session**,
- The usage of SCD and session keys as defined in **FCS\_COP.1/DSC** and **FCS\_COP.1/Session**

SF.INTEGRITY provides the integrity monitoring on the TOE. It encompasses:

- The integrity of sensitive data as defined in **FDP\_SDI.2/Persistent** and **FDP\_SDI.2/DTBS**,

SF.MANAGEMENT provides operation management and access control. It encompasses:

- Access management as defined in **FDP\_ACC.1** and **FDP\_ACF.1** SFR,
- Data input and output as defined in **FDP\_ETC.1**, **FDP\_ITC.1/SCD**, and **FDP\_ITC.1/DTBS**,
- Management of functions as defined in **FMT\_MOF.1** and **FMT\_SMF.1**,
- Management of security attributes **FMT\_MSA.1/AdminKG**, **FMT\_MSA.1/AdminKI**, **FMT\_MSA.1/Signatory**, **FMT\_MSA.2**, **FMT\_MSA.3/KeyImport**, **FMT\_MSA.3/KeyGen**, **FMT\_MSA.4/KeyImport**, **FMT\_MSA.4/KeyGen**,
- Management of TSF data as defined in **FMT\_MTD.1/Admin** and **FMT\_MTD.1/Signatory**,
- Management of roles as defined in **FMT\_SMR.1**,

	Reference <b>D1371562</b>	Release <b>1.0p</b> <small>(Printed copy not controlled: verify the version before using)</small>
	Classification Level <b>Public</b>	Pages <b>61</b>

SF.SECURE\_MESSAGING provides secure messaging for the TOE. It encompasses:

- Data exchange integrity and confidentiality as defined in **FDP\_UCT.1/SCD**, **FDP\_UIT.1/SVD Transfer**, and **FDP\_UIT.1/TOE DTBS**,
- Secure channel and secure path as defined in **FTP\_ITC.1/SCD Import**, **FTP\_ITC.1/SVD Transfer**, **FTP\_ITC.1/DTBS Import**, **FTP\_TRP.1/TOE**,

SF.CSM provides cards security protection. It encompasses:

- Protection against physical attacks as defined in **FPT\_EMS.1**, **FPT\_FLS.1**, **FPT\_PHP.1**, and **FPT\_PHP.3**,
- Testing of the card as defined in **FPT\_TST**,
- Secure unavailability of sensitive data as defined in **FDP\_RIP**.

### 7.1.2 TSFs provided by the platform

The evaluation is a composite evaluation and uses the results of the Platform CC .

SF	Description
SF_FW	Firewall
SF_API	Protection against snooping
SF.CSM	Card Security Management
SF.AID	AID Management
SF.INST	Installer
SF.ADEL	Applet Deletion
SF.ODEL	Object Deletion
SF.CAR	Secure Carrier
SF.SCP	Smart Card Platform
SF.CMG	Card Manager
SF.APIS	Specific API
SF.RND	RNG

**Table 16: Security Functions provided by the Multiapp V31 Platform**

These SF are described in [ST-PLTF].

	Reference <b>D1371562</b>	Release <b>1.0p</b> <small>(Printed copy not controlled: verify the version before using)</small>
	Classification Level <b>Public</b>	Pages <b>61</b>

## 7.2 TOE SUMMARY SPECIFICATION RATIONALE

### 7.2.1 TOE security functions rationale

Requirements	SF.Authentication	SF.Crypto	SF.Integrity	SF.Management	SF.Secure_Messaging	SF.CSM
FCS_CKM.1/SCD		X				
FCS_CKM.1/Session		X				
FCS_CKM.4/SCD		X				
FCS_CKM.4/Session		X				
FCS_COP.1/CORRESP		X				
FCS_COP.1/DSC		X				
FCS_COP.1/Session		X				
FDP_ACC.1/Initialization SFP				X		
FDP_ACC.1/SVD transfer SFP				X		
FDP_ACC.1/SCD import SFP				X		
FDP_ACC.1/Personalization SFP				X		
FDP_ACC.1/Signature-creation SFP				X		
FDP_ACF.1/Initialization SFP				X		
FDP_ACF.1/SVD transfer SFP				X		
FDP_ACF.1/SCD import SFP				X		
FDP_ACF.1/Personalization SFP				X		
FDP_ACF.1/Signature-creation SFP				X		
FDP_ETC.1				X		
FDP_ITC.1/SCD				X		
FDP_ITC.1/DTBS				X		
FDP_RIP.1						X
FDP_SDI.2/Persistent			X			
FDP_SDI.2/DTBS			X			
FDP_UCT.1/SCD					X	
FDP_UIT.1/SVD Transfer					X	
FDP_UIT.1/TOE DTBS					X	
FIA_AFL.1/PERSO	X					
FIA_AFL.1/SIG	X					
FIA_ATD.1	X					
FIA_UAU.1/PERSO	X					

Requirements	SF.Authentication	SF.Crypto	SF.Integrity	SF.Management	SF.Secure_Messaging	SF.CSM
FIA_UAU.1/SIG	X					
FIA_UID.1/PERSO	X					
FIA_UID.1/SIG	X					
FMT_MOF.1				X		
FMT_MSA.1/AdminKG				X		
FMT_MSA.1/AdminKI				X		
FMT_MSA.1/Signatory				X		
FMT_MSA.2				X		
FMT_MSA.3/KeyImport				X		
FMT_MSA.3/KeyGen				X		
FMT_MSA.4/KeyImport				X		
FMT_MSA.4/KeyGen				X		
FMT_MTD.1/Admin				X		
FMT_MTD.1/Signatory				X		
FMT_SMF.1				X		
FMT_SMR.1				X		
FPT_EMS.1						X
FPT_FLS.1						X
FPT_PHP.1						X
FPT_PHP.3						X
FPT_TST.1						X
FTP_ITC.1/SCD Import					X	
FTP_ITC.1/SVD Transfer					X	
FTP_ITC.1/DTBS Import					X	
FTP_TRP.1/TOE					X	

**Table 17: Rationale table of functional requirements and security functions**